

RIHO

čistá krása
Pure beauty
Чистая красота

vany / sprchové zástěny / koupelnový nábytek
bathtubs / shower screens / furniture
ванны / душевые шторы / мебель



WELLNESS 2013

RIHO

čistá krása
Pure beauty
Чистая красота

vany / sprchové zástěny / koupelnový nábytek
bathtubs / shower screens / furniture
ванны / душевые шторы / мебель

WELLNESSES 2013

OBSAH / CONTENT / СОДЕРЖАНИЕ

VANY / BATHTUBS / ВАННЫ

7-58

LITÉ VANY SOLID SURFACE BATHTUBS/ВАННЫ ИЗ ЛИТОГО МРАМОРА	7-10
AKRYLÁTOVÉ VANY/ACRYLIC BATHTUBS/АКРИЛАТНЫЕ ВАННЫ	
OBDELNÍKOVÉ RECTANGULAR / ПРЯМОУГОЛЬНЫЕ	11-25
ASYMETRICKÉ ASYMETRICAL / АСИММЕТРИЧНЫЕ	25-27
ROHOVÉ CORNER/УГЛОВЫЕ	27-29
DESIGNOVÉ DESIGN/ВАННЫ ДРУГИХ ФОРМ	29-31
PODPĚRY K VANÁM LEGSETS/НОЖКИ ДЛЯ ВАНН	32-33
MASÁŽNÍ SYSTÉMY MASSAGE SYSTEMS/МАССАЖНЫЕ СИСТЕМЫ	34-39
PŘÍSLUŠENSTVÍ ACCESSORIES/АКЦЕССУАРЫ	40-45
KRYCÍ PANEĽY COVER PANELS/ЗАЩИТНЫЕ ПАНЕЛИ	42-43
DOPLŇKY THE ACCESSORIES/ДОПОЛНИТЕЛЬНОЕ ОБОРУДОВАНИЕ	44
VANOVÉ ZÁSTĚNY BATHTUB SCREENS/ШТОРКИ ДЛЯ ВАНН	46-47
THERMAE LINE-SPECIÁLNÍ MASÁŽNÍ VANY SPECIAL MASSAGE BATHTUBS/СПЕЦИАЛЬНЫЕ МАССАЖНЫЕ ВАННЫ	48-57
INFORMACE INFORMATION/ИНФОРМАЦИЯ	58

SPRCHOVÉ ZÁSTĚNY, VANIČKY/SHOWER SCREENS, TRAYS/ДУШЕВЫЕ ШТОРКИ, ДУШЕВЫЕ ПОДДОНЫ 59-107

SPRCHOVÉ ZÁSTĚNY SHOWER SCREENS/ДУШЕВЫЕ ШТОРКИ	59-83
INFORMACE INFORMATION/ИНФОРМАЦИЯ	84-87
SPRCHOVÉ VANIČKY SHOWER TRAYS/ДУШЕВЫЕ ПОДДОНЫ	90-92
PODLAHOVÉ ŽLABY STAINLESS STEEL SHOWER DRAINS/НЕРЖАВЕЮЩИЕ ДУШЕВЫЕ ТРАПЫ	93-107

PARNÍ KABINY / STEAM CABINS / ПАРОВЫЕ КАБИНЫ

109-117

NÁBYTEK / FURNITURE / МЕБЕЛЬ

118-195















ANDORA, BOLOGNA, BRONI, EIFEL, ELZAS, ESTÉE, EVRY, LIGNA,
LUCCA, SLIMLINE, SMARTLINE, SCALA, AVANTI, VOLANO



VANY

BATHTUBS/ВАННЫ



	Aero / Aero / Аэро
	Hydro / Hydro / Гидро
	Hydro/Aero / Hydro/Aero / Гидро/Аэро
	Mechanická výpust s přepadem - délka 57 cm / Mechanical discharge with overflow - size 57 cm / Механический выпуск с перепадом - длина 57 см
	Mechanická výpust s přepadem - délka 70 cm / Mechanical discharge with overflow - size 70 cm / Механический выпуск с перепадом - длина 70 см
	Mechanická výpust s přepadem - délka 70 cm WP / Mechanical discharge with overflow - size 70 cm WP / Механический выпуск с перепадом - длина 70 cm WP
	Mechanická výpust s přepadem - délka 100 cm / Mechanical discharge with overflow - size 100 cm / Механический выпуск с перепадом - длина 100 см
	Mech. výpust s napouštěním přepadem - délka 57 cm / Mechanical discharge with overflow filling - size 57 cm / Выпуск с наполнением и переливом - длина 57cm
	Mech. výpust s napouštěním přepadem - délka 70 cm / Mechanical discharge with overflow filling - size 70 cm / Выпуск с наполнением и переливом - длина 70 cm
	Madlo / Handgrip / Ручка
	Madlo s napouštěním / Handgrip with overflow filling / Ручка с наливом воды
	Madlo Thermae / Handgrip Thermae / Ручка Thermae
	Krycí panel / Cover panel / Защитный панель
	Dřevěný panel / Wooden cover panel / Деревянный покрывающий панель
	Vanová zástěna / Bathtub screen / Душевая шторка
	Podhlavník / Headrest / Подголовник
	Pevná opěrka hlavy / Fixed headrest / Фиксированный подголовник
	Podhlavník Thermae / Headrest Thermae / Подголовник Thermae
	Podpěry universal / Legs universal / Ножки Universal
	Podpěry special / Legs special / Ножки special
	Podpěry strong / Legs strong / Ножки strong
	Osvětlení / Light / Освещение
	LCD displej / LCD display / LCD дисплей
	LCD PRO / LCD PRO / LCD PRO
	LCD LUX / LCD LUX / LCD LUX
	Přihřev / Heating / Обогрев
	Krycí deska / Coverplate / Защитная доска
	Colour terapie / Colour therapy / Хромотерапия
	Automatická čistící jednotka / Cleansystem / Автоматическая система дезинфекции
	Výška vany s podpěrami více než 60 cm / Tub height with legset more than 60 cm / Высота ванны с ножками более чем 60 см
	Poloha ve vaně vzhledem k umístění mikrotrysek / Position on the bath regarding the placement of microjets / Позиция согласна в зависимости от микрофорсунок

LITÉ VANY/SOLID SURFACE BATHTUBS/ВАННЫ ИЗ ЛИТОГО МРАМОРА



BARCELONA BS 05 170 x 70 cm / 275 l

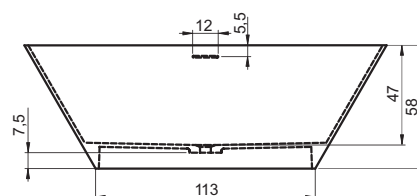
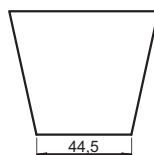
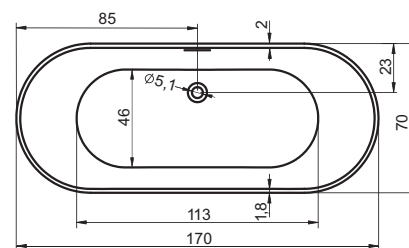

BILBAO BS 10 170 x 80 cm / 355 l
 BS 12 150 x 75 cm / 285 l

NEW

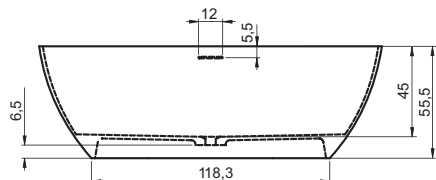
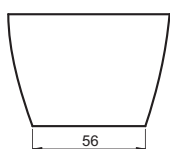
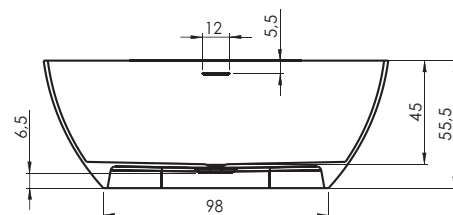
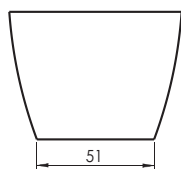
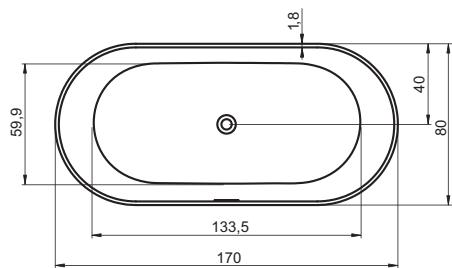
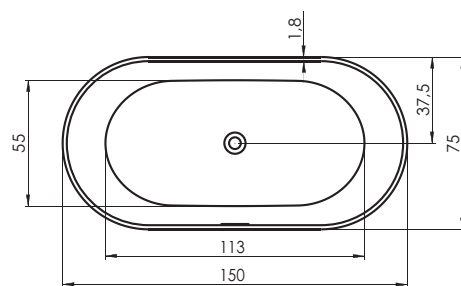

GRANADA BS 20 190 x 90 cm / 415 l

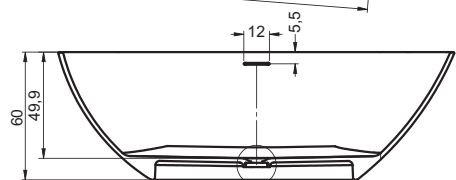
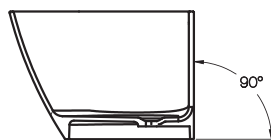
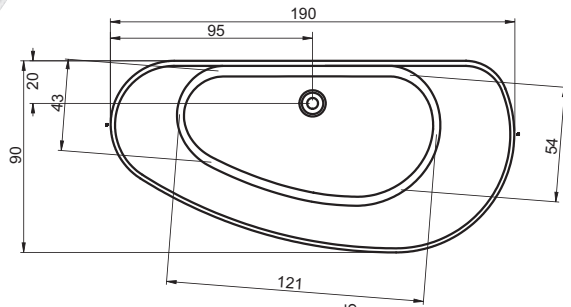

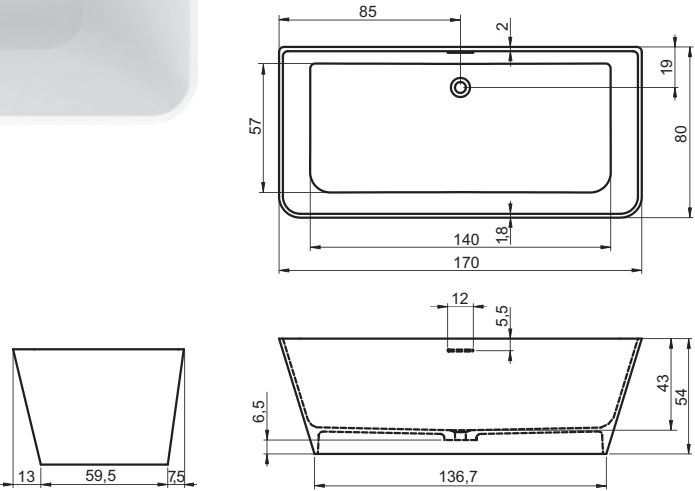
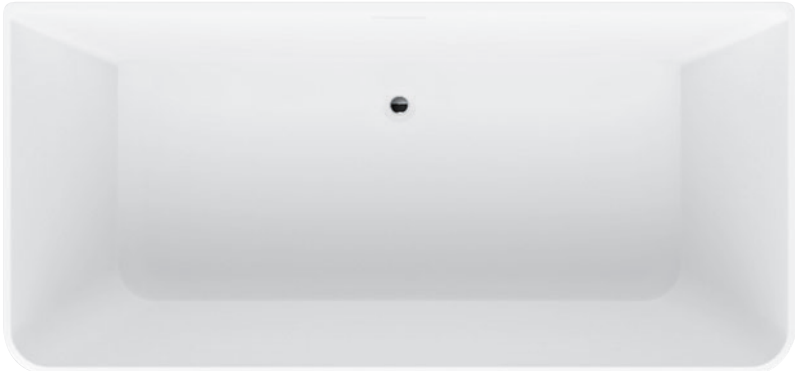

AKRYLÁTOVÉ VANY/ACRYLIC BATHTUBS/АКРИЛАТНЫЕ ВАННЫ

COLUMBIA BA05 140 x 70 cm / 175 l

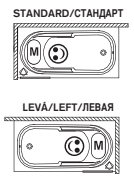
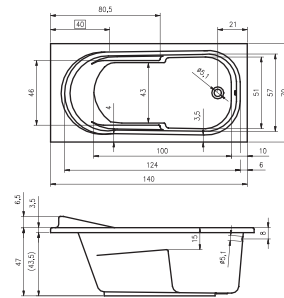

MIAMI BB58 150 x 70 cm / 160 l

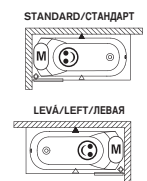
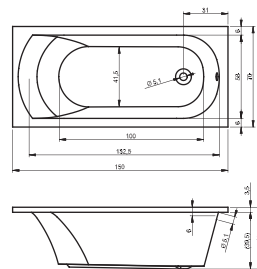

COLUMBIA BA02 150 x 75 cm / 190 l

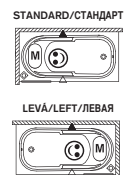
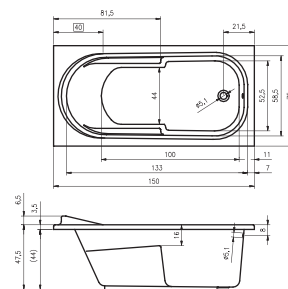

KLASIK BZ22 150 x 70 cm / 165 l

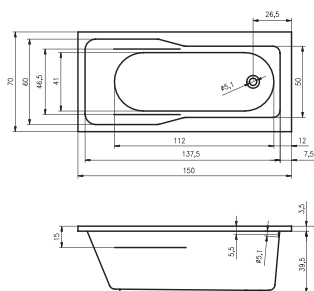

LIMA L BB41 / R BB40 150 x 70 cm / 160 l

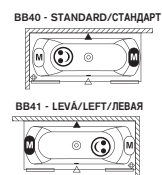
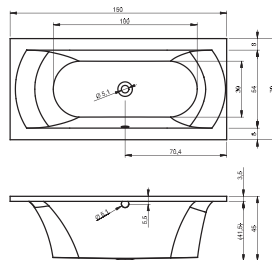

LIMA L BB43 / R BB42 160 x 70 cm / 175 l

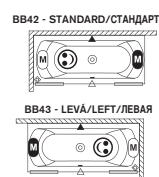
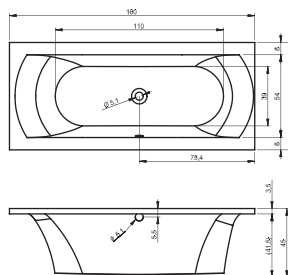

JULIA BA71 160 x 70 cm / 275 l

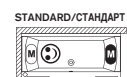
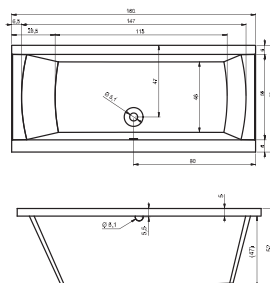

* Při použití krycího panelu nutno zapustit sifon do podlahy
 /When cover panel is used siphon has to be embedded in the floor
 /При использовании покрывающей панели сифон следует утопить в пол

MIAMI BB60 160 x 70 cm / 170 l

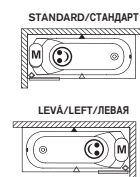
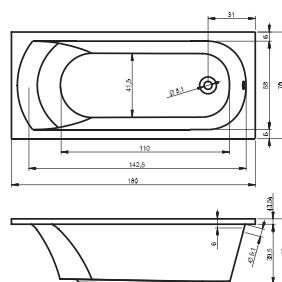

KLASIK BZ16 160 x 70 cm / 185 l

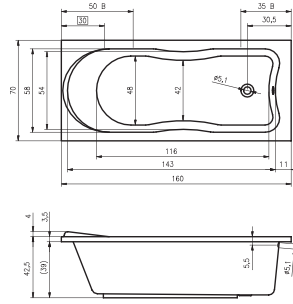

STANDARD/СТАНДАРТ



LEVÁ/LEFT/ЛЕВАЯ



COLUMBIA BA01 160 x 75 cm / 180 l

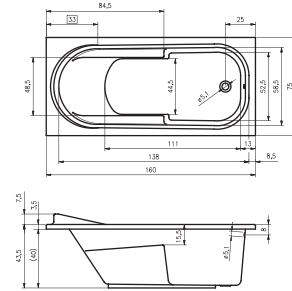

STANDARD/СТАНДАРТ

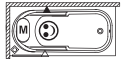

LEVÁ/LEFT/ЛЕВАЯ

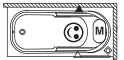

MIAMI BB62 170 x 70 cm / 185 l

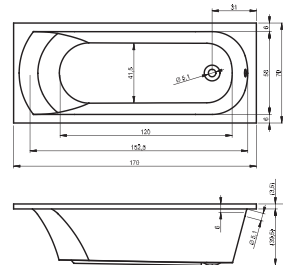

STANDARD/СТАНДАРТ

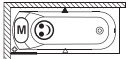

LEVÁ/LEFT/ЛЕВАЯ

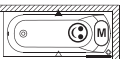

LIVORNO BB71 170 x 80 cm / 250 l

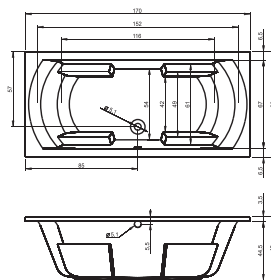

STANDARD/СТАНДАРТ



LEVÁ/LEFT/ЛЕВАЯ

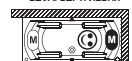

CAROLINA BB53 170 x 80 cm / 270 l

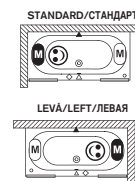
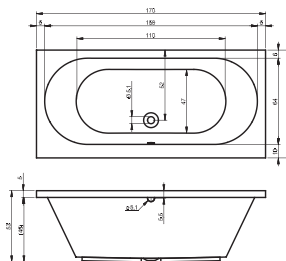

* Při použití krycího panelu nutno zapustit sifon do podlahy
 /When cover panel is used siphon has to be embedded in the floor
 /При использовании покрывающей панели сифон следует утопить в пол

DORADO L BA81 / R BA80 170 x 75/90 cm / 285 l

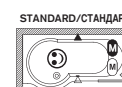
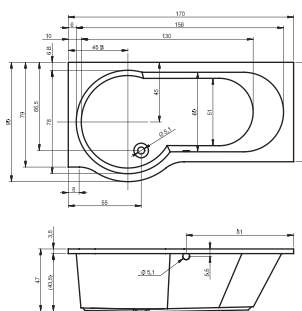

FUTURE BC28 170 x 75 cm / 195 l

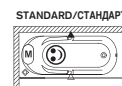
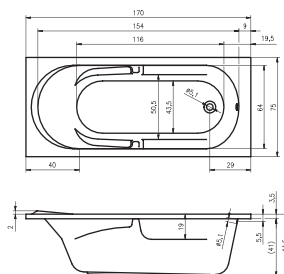

LIMA L BB45 / R BB44 170 x 75 cm / 210 l

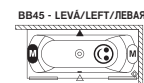
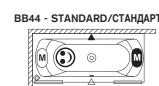
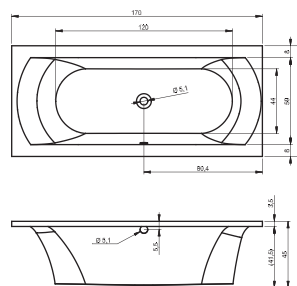

LUSSO BA18 170 x 75 cm / 250 l

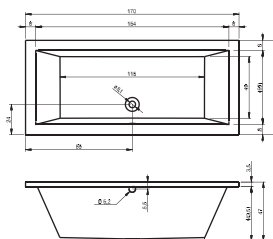

STANDARD/СТАНДАРТ

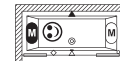

LEVÁ/LEFT/ЛЕВАЯ

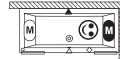

ORION BC01 170 x 70 cm / 230 l

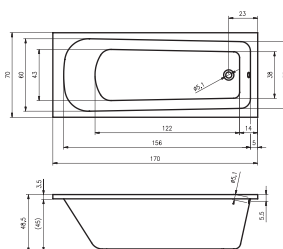

STANDARD/СТАНДАРТ

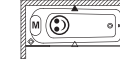

LEVÁ/LEFT/ЛЕВАЯ

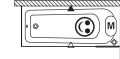

TAURUS BC07 170 x 80 cm / 235 l

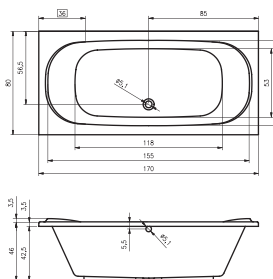

STANDARD/СТАНДАРТ

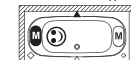

LEVÁ/LEFT/ЛЕВАЯ



LUSSO PLUS BA12 170 x 80 cm / 295 l

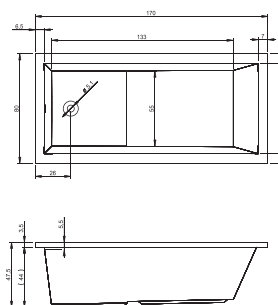

STANDARD/СТАНДАРТ

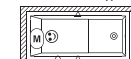

LEVÁ/LEFT/ЛЕВАЯ



VIRGO BZ07 170 x 75 cm / 235 l

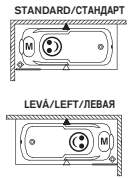
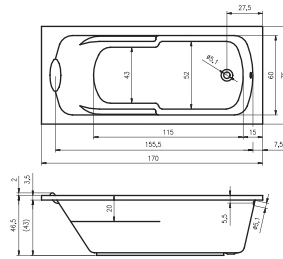

KLASIK BZ19 170 x 70 cm / 210 l

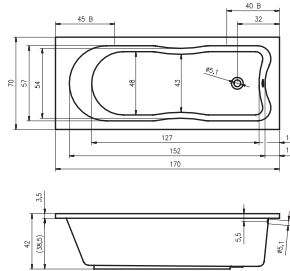

COLUMBIA BA04 175 x 80 cm / 255 l

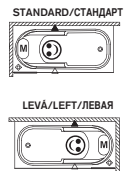
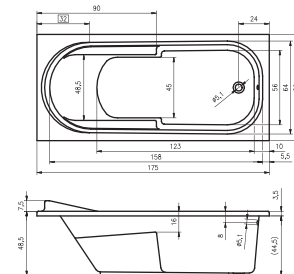

MIAMI BB64 180 x 80 cm / 220 l

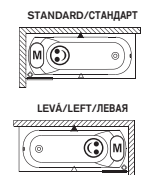
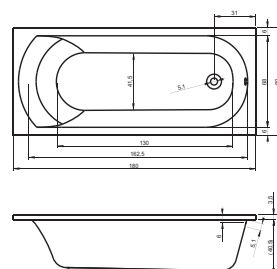

CAROLINA BB54 180 x 80 cm / 290 l

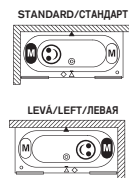
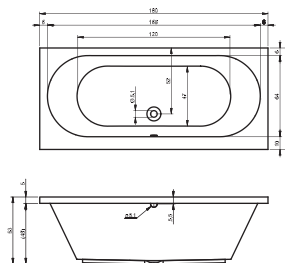

* Při použití krycího panelu nutno zapustit sifon do podlahy
/When cover panel is used siphon has to be embedded in the floor
/При использовании покрывающей панели сифон следует утопить в пол

SUPREME BA55 180 x 80 cm / 230 l

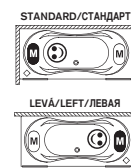
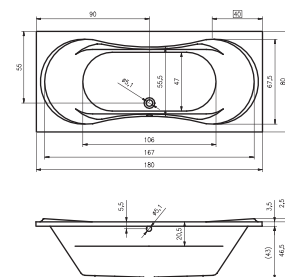

DAYTONA BB51 180 x 80 cm / 290 l

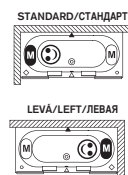
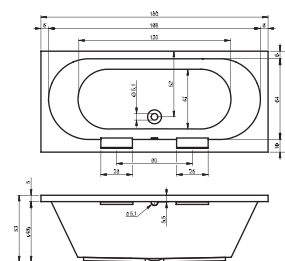

* Při použití krycího panelu nutno zapustit sifon do podlahy
/When cover panel is used siphon has to be embedded in the floor
/При использовании покрывающей панели сифон следует утопить в пол

FUTURE BC31 180 x 80 cm / 225 l

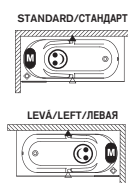
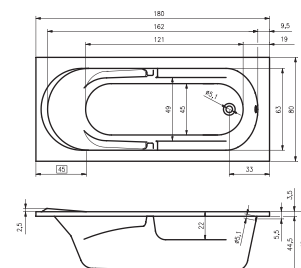

LIMA L BB47 / R BB46 180 x 80 cm / 275 l

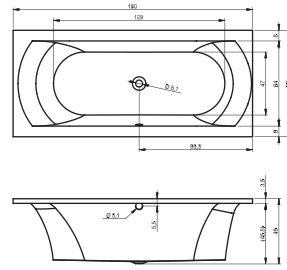

BB46 - STANDARD/СТАНДАРТ

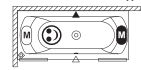

BB47 - LEVÁ/LEFT/ЛЕВАЯ

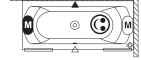

LIVORNO BB72 180 x 80 cm / 270 l

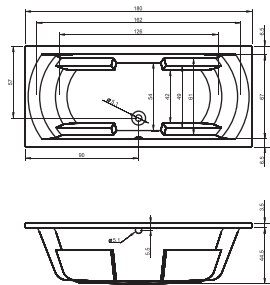

STANDARD/СТАНДАРТ

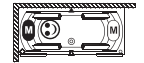

LEVÁ/LEFT/ЛЕВАЯ

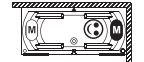

LUSSO BA98 180 x 80 cm / 295 l

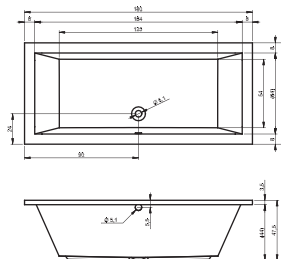

STANDARD/СТАНДАРТ

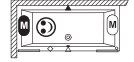

LEVÁ/LEFT/ЛЕВАЯ

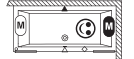

GENOVA BB87 180 x 80 cm / 270 l

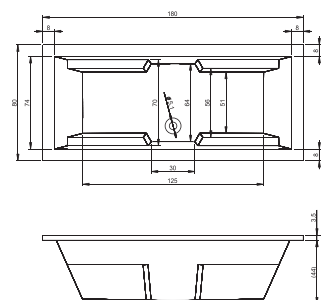

STANDARD/СТАНДАРТ

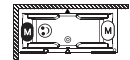

LEVÁ/LEFT/ЛЕВАЯ

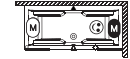

JULIA BA72 180 x 80 cm / 340 l

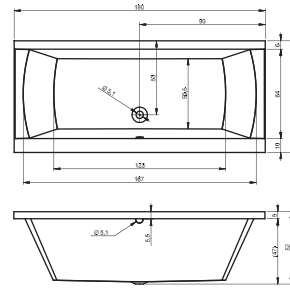

* Při použití krycího panelu nutno zapustit sifon do podlahy
 /When cover panel is used siphon has to be embedded in the floor
 /При использовании покрывающей панели сифон следует утопить в пол

LUSSO BA77 180 x 90 cm / 330 l

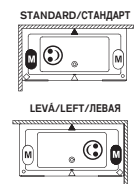
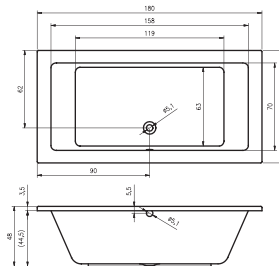

TOFIELD BA37 180 x 80 cm / 245 l

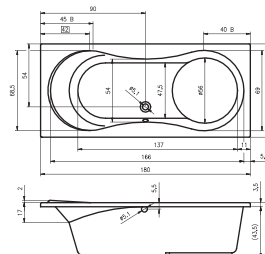

MODENA BA79 180 x 80 cm / 340 l

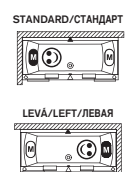
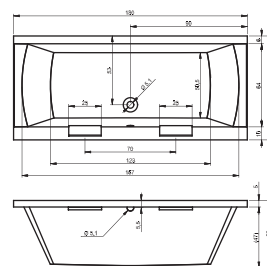

MONTREAL BA13 180 x 90 cm / 275 l

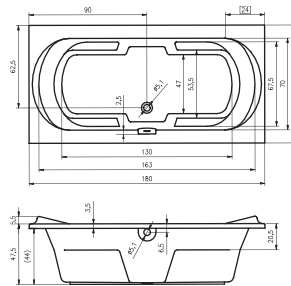

STANDARD/СТАНДАРТ

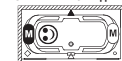

LEVÁ/LEFT/ЛЕВАЯ

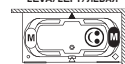

OTTAWA BA52 180 x 80 cm / 265 l

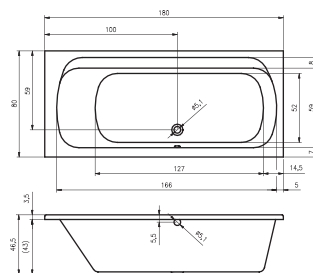

STANDARD/СТАНДАРТ

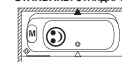

PEGAS BC16 180 x 80 cm / 215 l

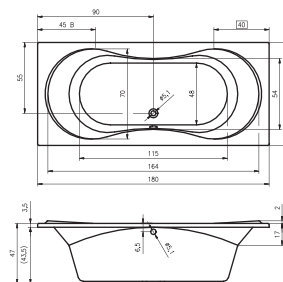

STANDARD/СТАНДАРТ

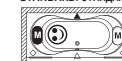

LEVÁ/LEFT/ЛЕВАЯ

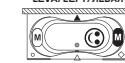

SOBEK BB28 180 x 115 cm / 485 l

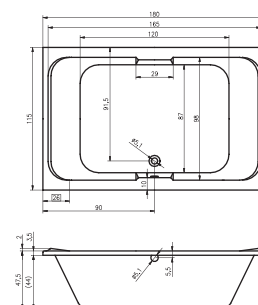

STANDARD/СТАНДАРТ

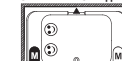

LEVÁ/LEFT/ЛЕВАЯ



CASTELLO BB77 180 x 120 cm / 495 l

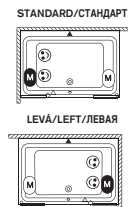
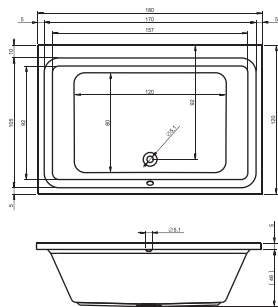

DIMARO BB78 180 x 90 cm / 330 l

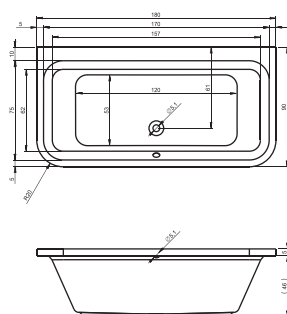

LIVORNO BB73 190 x 90 cm / 320 l

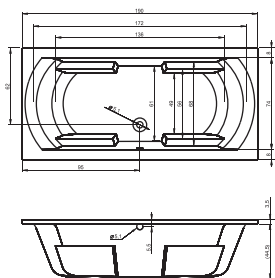

LUSSO BA59 190 x 80 cm / 315 l

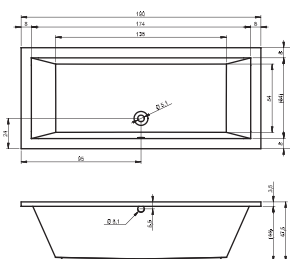

LUSSO BA99 190 x 90 cm / 370 l

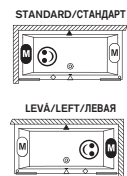
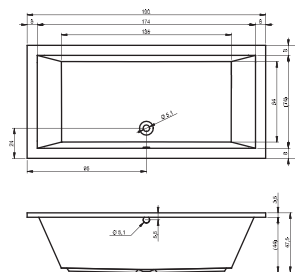

JULIA BA69 190 x 90 cm / 400 l

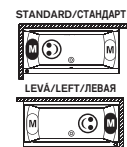
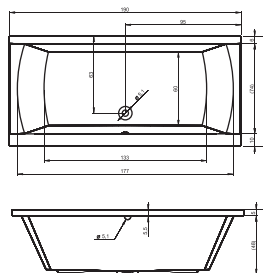

* Při použití krycího panelu nutno zapustit sifon do podlahy
 /When cover panel is used siphon has to be embedded in the floor
 /При использовании покрывающей панели сифон следует утопить в пол

CALGARY BA14 190 x 90 cm / 275 l

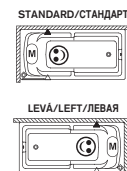
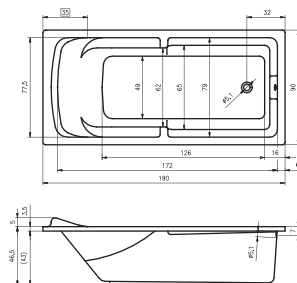

CAROLINA BB55 190 x 80 cm / 315 l

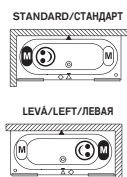
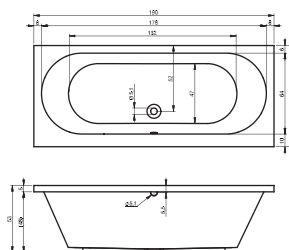

* Při použití krycího panelu nutno zapustit sifon do podlahy
 /When cover panel is used siphon has to be embedded in the floor
 /При использовании покрывающей панели сифон следует утопить в пол

LIMA BB48 190 x 90 cm / 320 l

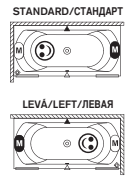
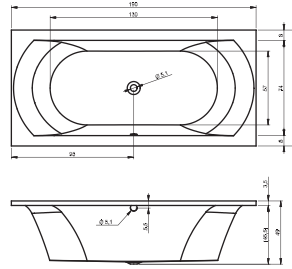

SUPREME BA58 190 x 90 cm / 265 l

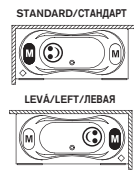
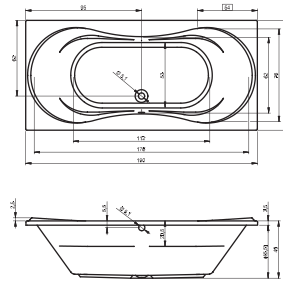

MODENA BA94 190 x 90 cm / 400 l

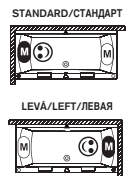
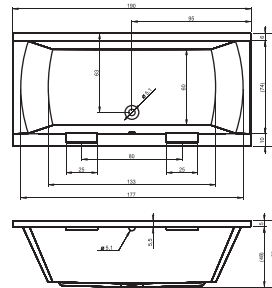

MONTREAL BA15 190 x 90 cm / 290 l

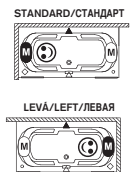
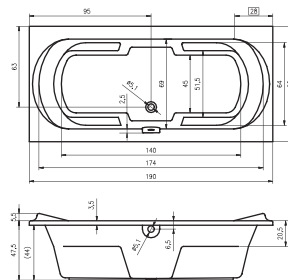

LUSSO BA60 200 x 90 cm / 390 l

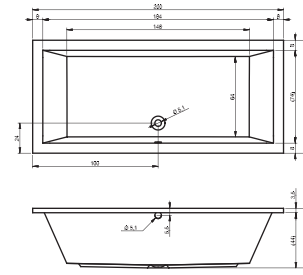

STANDARD/СТАНДАРТ



LEVÁ/LEFT/ЛЕВАЯ

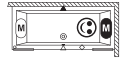

LIMA BB49 200 x 90 cm / 350 l

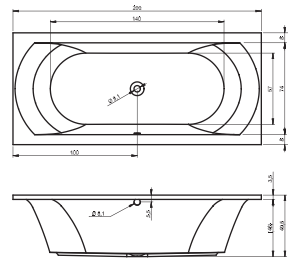

STANDARD/СТАНДАРТ



LEVÁ/LEFT/ЛЕВАЯ

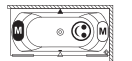

LYRA L BA66 / R BA65 140 x 90 cm / 200 l

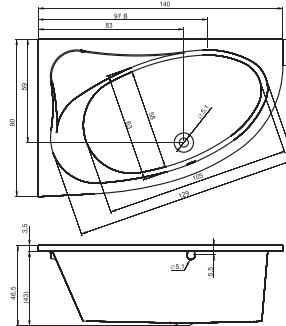

STANDARD/СТАНДАРТ



BA66 L R BA65

LYRA L BA68 / R BA67 153,5 x 100,5 cm / 230 l

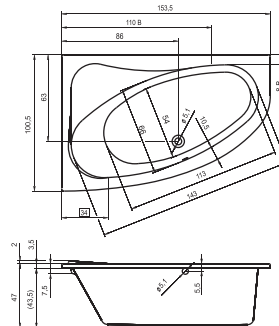

STANDARD/СТАНДАРТ



BA68 L R BA67

LYRA L BA64 / R BA63 170 x 110 cm / 280 l

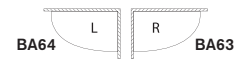
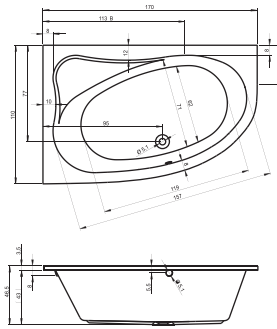

DELTA L BB81 / R BB80 150 x 80 cm / 190 l

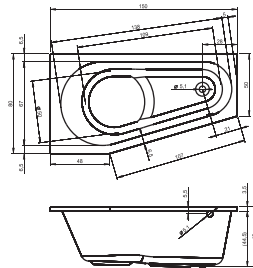

DELTA L BB83 / R BB82 160 x 80 cm / 210 l

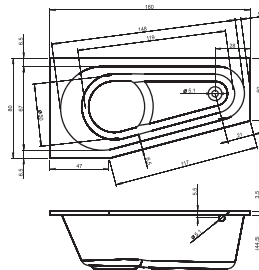

GETA L BA87 / R BA86 160 x 90 cm / 300 l

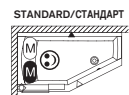
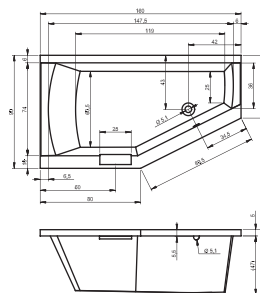

NORA L BA75 / R BA74 160 x 100 cm / 240 l

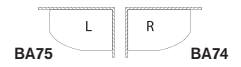
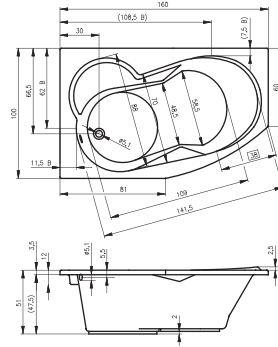

YUKON L BA35 / R BA34 160 x 90 cm / 255 l

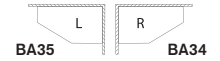
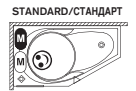
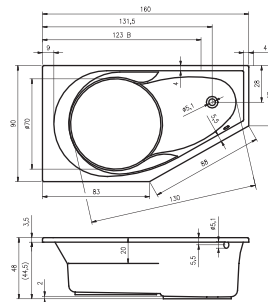

GETA L BA89 / R BA88 170 x 90 cm / 310 l

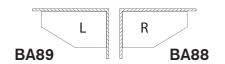
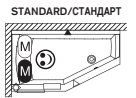
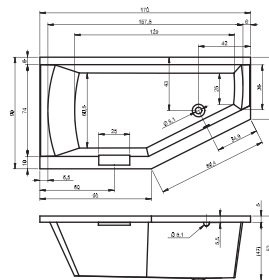

DOPPIO L BA91 / R BA90 180 x 130 cm / 395 l

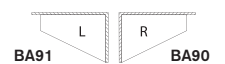
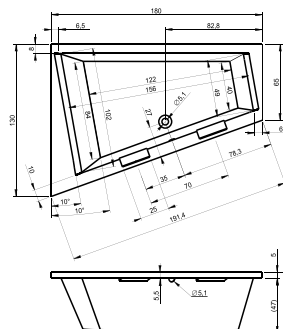

NEO BC34 140 x 140 cm / 315 l

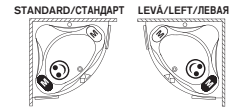
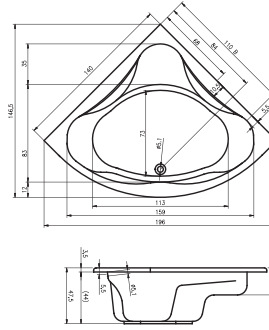

ATLANTA BB70 140 x 140 cm / 340 l

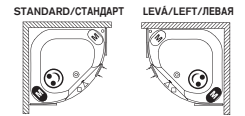
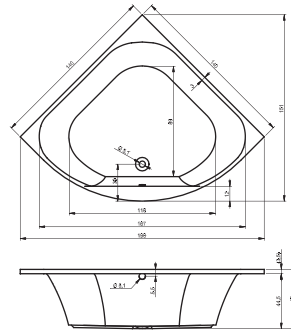

AUSTIN BA11 145 x 145 cm / 350 l

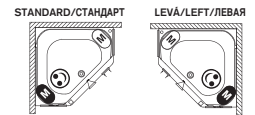
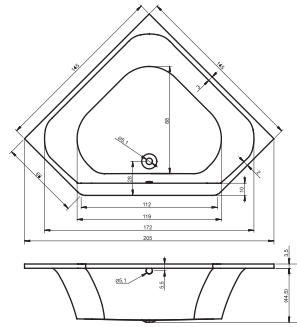

SANTIAGO BA06 145 x 145 cm / 330 l

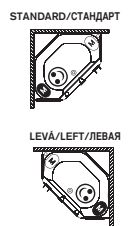
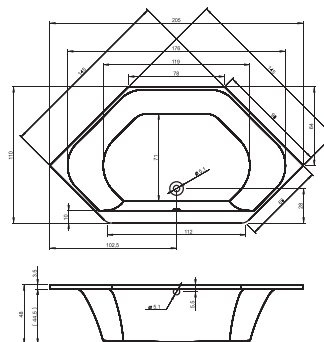

SYDNEY BA95 145 x 145 cm / 310 l

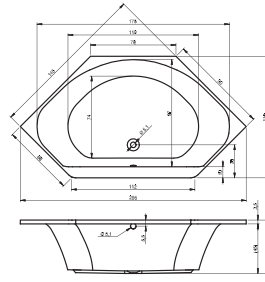

STANDARD/СТАНДАРТ

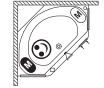

LEVÁ/ЛЕФТ/ЛЕВАЯ

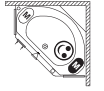

NEO BC35 150 x 150 cm / 365 l

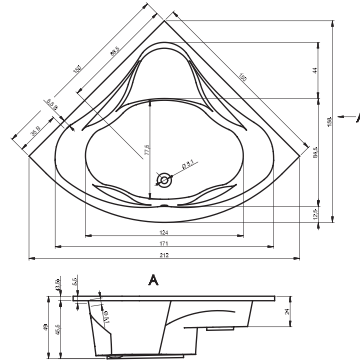

STANDARD/СТАНДАРТ



LEVÁ/ЛЕФТ/ЛЕВАЯ

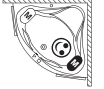

WINNIPEG BA48 145 x 145 cm / 305 l

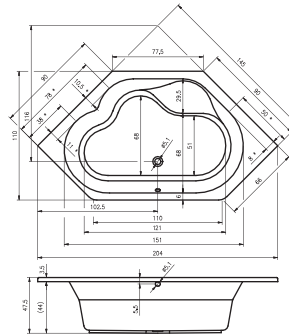

STANDARD/СТАНДАРТ



COLORADO BB02 180 cm / 600 l

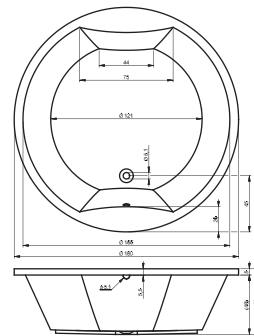

STANDARD/СТАНДАРТ



SETH BB22 180 x 86 cm / 245 l

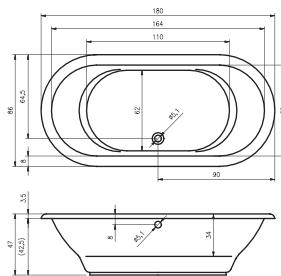

SETH WP BB23 180 x 86 cm / 245 l

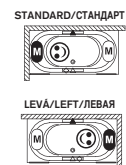
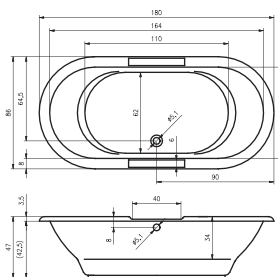

Pouze pro masážní systémy / only for whirlpools / только для массажных ван

ALBERTA BA31 190 x 80 cm / 245 l

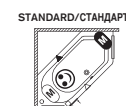
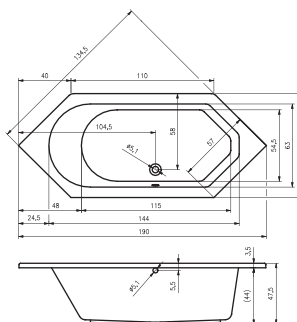

KANSAS BA97 190 x 90 cm / 260 l

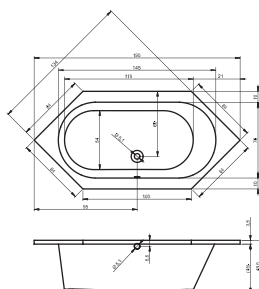

LUGANO BA78 190 x 90 cm / 295 l

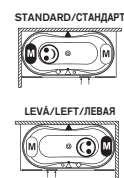
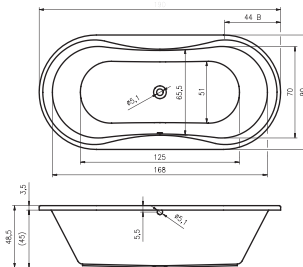

PETIT BZ25 120 x 70 cm / 135 l

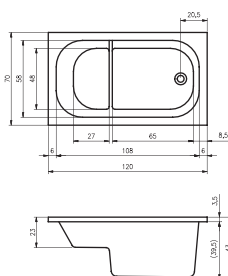

Podpěry k vanám / Legsets / Ножки для ванн

UNIVERSAL *POOTSET01U*

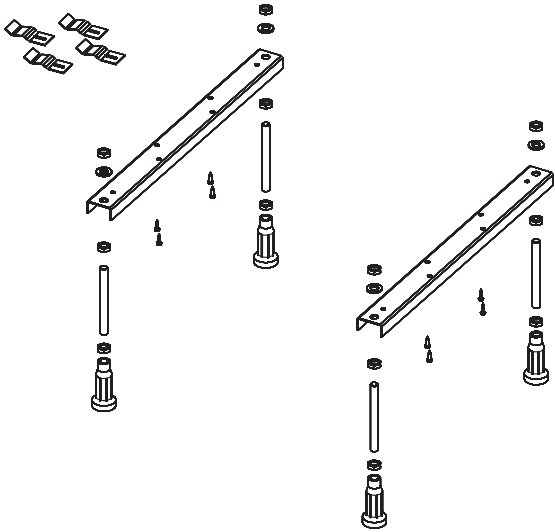

SPECIAL PLUS *POOTSET07*

určeno pro vanu/for bathtub/для ванны:
AUSTIN, LIMA 190, LIMA 200, NEO150, KANSAS,
SYDNEY, SOBEK, LUSO 180x90, LUSO
190x90, LUSO 200x90, ATLANTA, JULIA 190,
MODENA190, LIVORNO 190, SANTIAGO,
CASTELLO

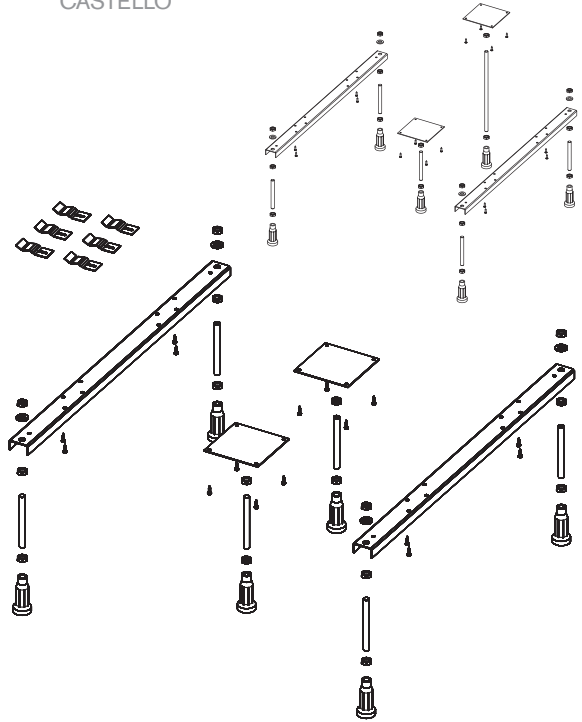

STRONG *POOTSET08*

určeno pro vanu/for bathtub/для ванны:
LYRA153, LYRA140, NEO140, NORA

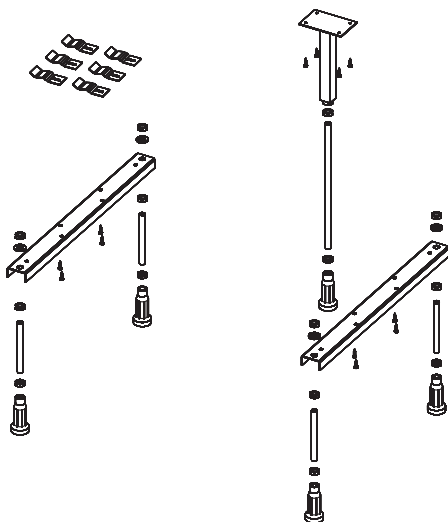

SPECIAL 09 *POOTSET09*

určeno pro vanu/for bathtub/для ванны:
YUKON, DOPPIO, DORADO, GETA160, 170

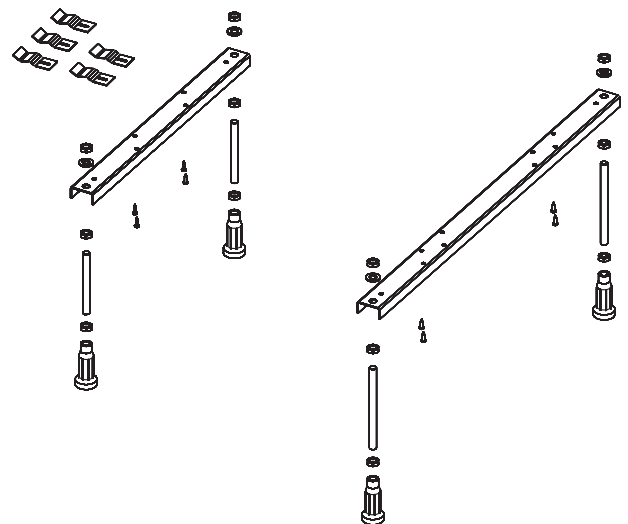

Podpěry k vanám / Legsets / Ножки для ванн

SPECIAL 06 POOTSET06

určeno pro vanu/for bathtub/для ванны: LUGANO, DIMARO
volně stojící/freestanding/отдельно стоящий

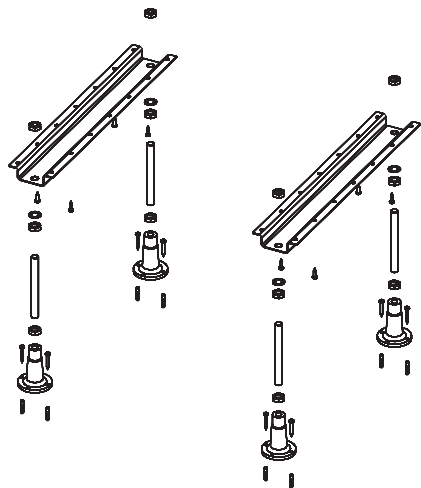

SPECIAL 12

určeno pro vanu/for bathtub/для ванны: PETIT

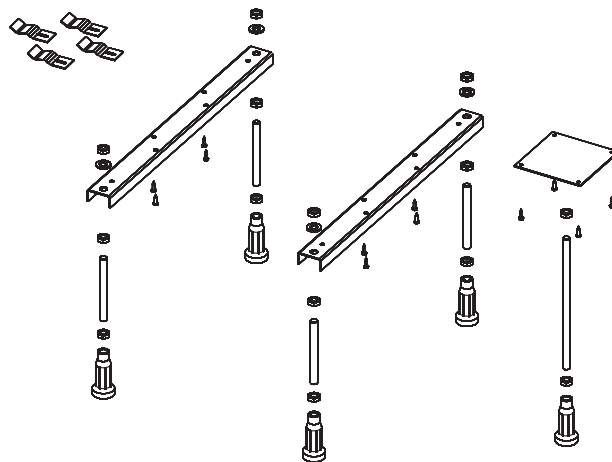

SPECIAL 14 POOTSET14

určeno pro vanu/for bathtub/для ванны: COLORADO

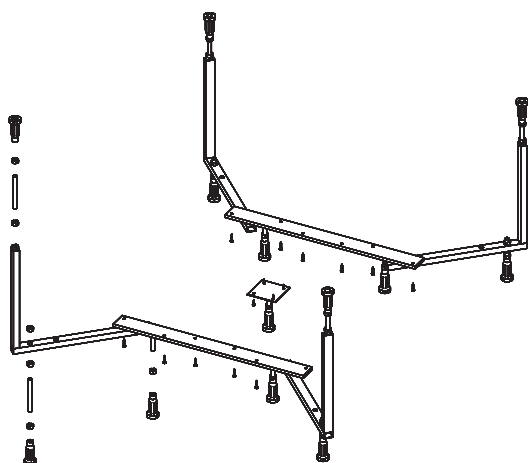

Podpěry k panelům Legsets for panels Ножки для панелей

Není určeno pro vany
It is not possible to use
for the bathtubs/Невозможно
использовать для ванн:
COLUMBIA 140, CALGARY,
OTTAWA, ORION, KLASIK 150,
KLASIK 160, KLASIK 170



HIT

masážní systém s mechanickým ovládním
massage system with mechanical control
массажная система с механическим управлением

AERO 11



mechanické ovládním
mechanical control
механическое управление



HYDRO 6+4+2



trysky/jets/форсунки



Hydro



Aero



Micro



Sání/Suction/Всасывание

HYDRO 6+4+2 / AERO 11



AERO 10 - LIMA, LUGANO
AERO 12 - DORADO, DOPIO, KANSAS
HYDRO 4+4+2 - DORADO

AERO 19 - ATLANTA, AUSTIN, SOBEK, CASTELLO
AERO 24 - COLORADO

TOP

masážní systém s elektronickým ovládáním
massage system with electronic control
массажная система с электронным управлением

HYDRO 6+4+2



elektronické ovládání
electronic control
электронное управление



E1



E2B

HYDRO 6+4+2 / AERO 11



trysky/jets/форсунки



Hydro



Aero



Micro



Sání/Suction/Всасывание

AERO 10 - LIMA, LUGANO
AERO 12 - DORADO, DOPIO, KANSAS
HYDRO 4+4+2 - DORADO

AERO 19 - ATLANTA, AUSTIN, SOBEK, CASTELLO
AERO 24 - COLORADO

PRO

masážní systém s elektronickým ovládním
 massage system with electronic control
 массажная система с электронным управлением

přihřev pouze s LCD displejem
 heating only with LCD display
 дополнительный обогрев только с LCD дисплеем

AERO 11 + světlo/light/подсветка



elektronické ovládní
 electronic control
 электронное управление



E5



E7



LCD displej
 LCD display
 LCD дисплей

HYDRO 6+4+2 + světlo/light/подсветка + čistící jednotka/clean/система дезинфекции



trysky/jets/форсунки



Hydro



Aero



Micro



Sání/Suction/Всасывание

HYDRO 6+4+2 / AERO 11 + světlo/light/подсветка + čistící jednotka/clean/ система дезинфекции



AERO 10 - LIMA, LUGANO
 AERO 12 - DORADO, DOPIO, KANSAS
 HYDRO 4+4+2 - DORADO

AERO 19 - ATLANTA, AUSTIN, SOBEK, CASTELLO
 AERO 24 - COLORADO

PRO Plus

masážní systém s elektronickým ovládáním
massage system with electronic control
массажная система с электронным управлением

přihřev pouze s LCD displejem
heating only with LCD display
дополнительный обогрев только с LCD дисплеем

HYDRO 8+6+2 / AERO 16 + světlo/light/подсветка
+ čisticí jednotka/clean/
система дезинфекции



elektronické ovládání
electronic control
электронное управление



E5



E7



LCD displej
LCD display
LCD дисплей

Pouze pro vany
Only for the bath tubs

Только для ван

Carolina	180, 190
Daytona	180
Genova	180
Lima	180, 190, 200
Livorno	180, 190
Lusso	180x80, 180x90, 190x80, 190x90, 200x90
Modena	180, 190
Montreal	180, 190
Julia	180, 190

trysky/jets/форсунки



Hydro



Aero



Micro

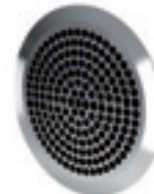

Sání/Suction/Всасывание

LUX přívěv pouze s LCD displejem
heating only with LCD display
дополнительный обогрев только с LCD дисплеем

masážní systém s elektronickým ovládáním
massage system with electronic control
массажная система с электронным управлением

HYDRO 4+4+2



HYDRO 4+4+2 + světlo/light/подсветка
HYDRO 4+4+2 + světlo/light/подсветка
+ čisticí jednotka/clean/система дезинфекции



HYDRO 4+4+2 / AERO 11
HYDRO 4+4+2 / AERO 11 + světlo/light/подсветка
HYDRO 4+4+2 / AERO 11 + světlo/light/подсветка
+ čisticí jednotka/clean/система дезинфекции



elektronické ovládání
electronic control
электронное управление



E5



E7



LCD displej
LCD display
LCD дисплей

trysky/jets/форсунки



Maxi



Aero



Micro



Sání/Suction/Всасывание

AERO 10 - LIMA, LUGANO
AERO 19 - ATLANTA,
AUSTIN, SOBEK, CASTELLO

AERO 12 - DORADO,
DOPIO, KANSAS

AERO 24 - COLORADO

HYDRO TRYSKA
HYDRO JET
ГИДРОФОРСУНКА



MAXI TRYSKA
MAXI JET
МАКСИФОРСУНКА



MINI TRYSKA
MINI JET
МИКРОФОРСУНКА



AERO TRYSKA
AERO JET
АЭРОФОРСУНКА



SÁNI
SUCTION
ВСАСЫВАНИЕ



Podhlavníky / Headrests / Подголовники

Pevné opěrky hlavy/Fixed headrest/Прочные подголовники

AH01



AH09



Všechny podhlavníky jsou dostupné také v černém provedení/All headrests are also available in a black version/Все подголовники доступны также в черном исполнении

Podhlavníky vyrobeny z PUR
Headrests are made of PUR/
Подголовники изготовлены из полиуритана

Podhlavníky/ Headrest/Подголовники

AH03



AH04



AH05

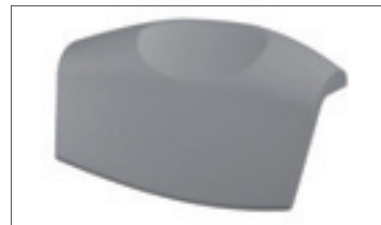

AH06



AH07



AH08



AH10



AH11



AH12



AH13



AH14



AH15



AH16

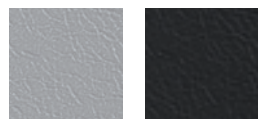

Doplňky / Accessories / Дополнительное оборудование

Madlo Standard Handgrip Standard Ручка Стандарт

Také v černé
Also in black
Также в черном исполнении



VYROBENO z PUR s výztuhou
Made of PUR with steel reinforcements
ИЗГОТОВЛЕНО ИЗ ПОЛИУРИТАНА с крепежом

Madlo Lux (Thermae) Handgrip Lux (Thermae) Ручка Lux (Thermae)

VYROBENO z leštěné nerezí
Polished stainless steel
ИЗГОТОВЛЕНО из
полированной из
нержавеющей стали



Madlo s napouštěním* Handgrip with filling Ручка с наполнением

Pouze pro vany/Only for the bath tubs
/Толко для ван
DOPIO, MODENA, GETA, DAYTONA

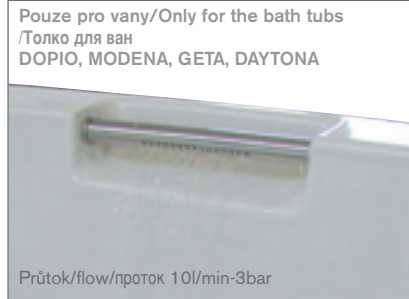

Průtok/flow/проток 10l/min-3bar

Držák ručníku Towel rail Держатель полотенец



DÉLKA 82 cm
LENGTH 82 cm
ДЛИНА 82 см

Mechanická výpust s přepadem Mechanical discharge with overflow filling Механический выпуск с перепадом

DÉLKA 575mm, 700mm, 1000mm
LENGTH 575mm, 700mm, 1000mm
ДЛИНА 575mm, 700mm, 1000mm

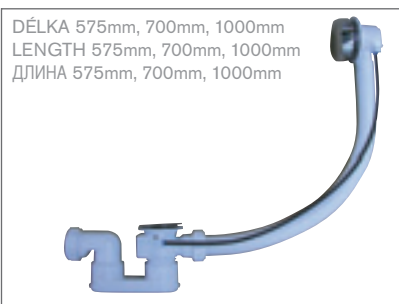

Výpust s napouštěním přepadem Discharge with overflow filling Выпуск с наполнением и переливом



HLOBKA/DEPTH/ГЛУБИНА 7 cm
Průtok/flow/проток 25l/min-3bar

Odtoková a přepadová souprava pro přívod vody přes odpad Mechanical Discharge with waste filling from bottom – Multiplex Слив-перелив с наполнение через слив (Мульти-Слив)



Průtok/flow/проток 23s/1min-3bar
Odtok/outflow/сток 51l/min

Výpust ke sprchové vaničce Discharge for shower trays Выпуск к душевому поддону



Ø50 mm, výška 80 mm Ø90 mm, výška 80 mm
Ø50 mm, height 80 mm Ø90 mm, height 80 mm
Ø50 mm, высота 80 mm Ø90 mm, высота 80 mm

Příhřev (pouze s LCD) Heating (only with LCD) Дополнительный обогрев (только с LCD)

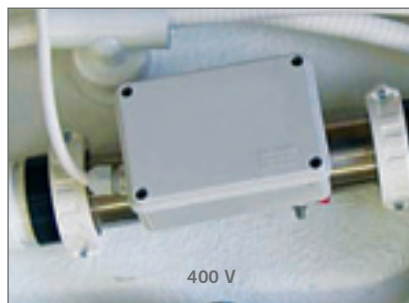

400 V

Napouštění tryskami/ jet filling/ наполнение водой через форсунки



Světlo/Light/Подсветка TOP, PRO, LUX



Colour terapie/Colour therapy/Хромотерапия rouze pro TOP, PRO, LUX/only for LUX and PRO/только для LUX и PRO



Krčí panely / Cover Panels / Защитные панели

Krčí panely k rovným vanám/Cover panels for classic bathtubs/Защитные панели к прямоугольным ваннам



	A	C	B	C	(cm)
	140	140	70	70	57
	150	150	75	75	57
	160	160	80	80	57
	170	170	90	90	57
	175	175			57
	180	180			57
	190	190			57
	200	200			57

Doplňěk/Accessory
Дополнительное
оборудование

Podpěry k panelům
Legsets for panels
Ножки для панелей



Krčí panely k rohovým vanám/ Cover panels for corner bathtubs/Защитные панели к угловым ваннам

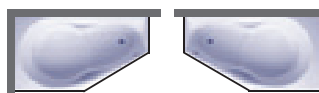
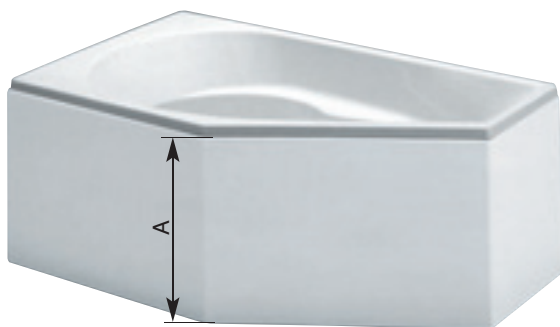

DORADO L/P



LYRA 140/150/170



WINNIPEG/AUSTIN
/SYDNEY/SANTIAGO



LUGANO



NEO 140/150



DIMARO



ATLANTA



YUKON



NORA



LYRA 140/153



DELTA 160



GETA 160/170



Dřevěné krycí panely Wooden cover panels Деревянные покрывающие панели

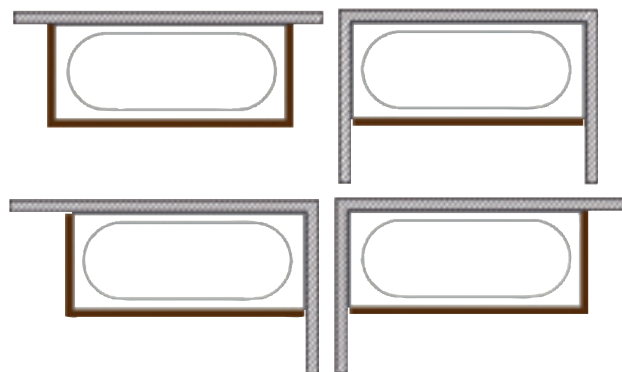

P075BLK	PANEL 75 - DECOR DŘEVO ČERNÉ/DECOR WOOD BLACK	75x57
P075DOR	PANEL 75 - DECOR DŘEVO ORME/DECOR WOOD ORME	75x57
P083BLK	PANEL 80 - DECOR DŘEVO ČERNÉ/DECOR WOOD BLACK	80x57
P083DOR	PANEL 80 - DECOR DŘEVO ORME/DECOR WOOD ORME	80x57
P095BLK	PANEL 90 - DECOR DŘEVO ČERNÉ/DECOR WOOD BLACK	90x57
P095DOR	PANEL 90 - DECOR DŘEVO ORME/DECOR WOOD ORME	90x57
P170BLK	PANEL 170 - DECOR DŘEVO ČERNÉ/DECOR WOOD BLACK	170x57
P170DOR	PANEL 170 - DECOR DŘEVO ORME/DECOR WOOD ORME	170x57
P180BLK	PANEL 180 - DECOR DŘEVO ČERNÉ/DECOR WOOD BLACK	180x57
P180DOR	PANEL 180 - DECOR DŘEVO ORME/DECOR WOOD ORME	180x57
P190BLK	PANEL 190 - DECOR DŘEVO ČERNÉ/DECOR WOOD BLACK	190x57
P190DOR	PANEL 190 - DECOR DŘEVO ORME/DECOR WOOD ORME	190x57

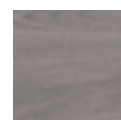

DOR orme



BLK černá

Materiál: vodotěsná dřevotříska/water - resistant chip board/водоуморная ДСМ

RIHO CARE

Čistící prostředky/Cleaning articles/Моющее средства



AT05003 Čistič na skleněné výrobky 500ml
Cleaner for glass screens
Моющее средство для стеклянных шторок



AT05004 Čistič na akrylátové výrobky 500ml
Cleaner for acrylic products
Моющее средство для акрилатовой продукции



AT05005 Univerzální čistič koupelen 500ml
Universal bathroom cleaner
Универсальное моющее средство для ванн



AT05006 Čistič na odpady 450 ml
Cleaner waste
Моющее средство для водостоків

Clean systém/Clean system/Система дезинфекции



REDIS0001
Dezinfekce – tablety
Dezinfektion – tablets
Дезинфекция – таблетки



REDIS0002
Tekutina do čistící jednotky
Fluid to the clean systém
Дезинфекция – жидкость

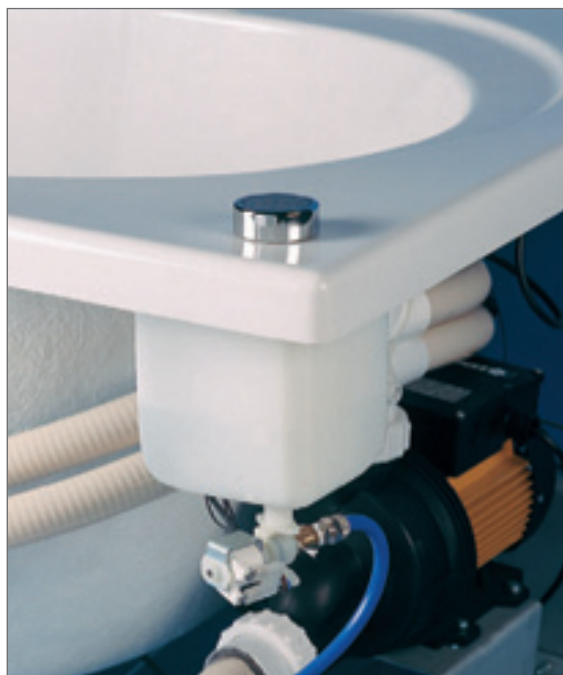

Čistící jednotka
clean system
комплект системы дезинфекции



Vanové zástěny / Bathtub screens / Ванные шторки

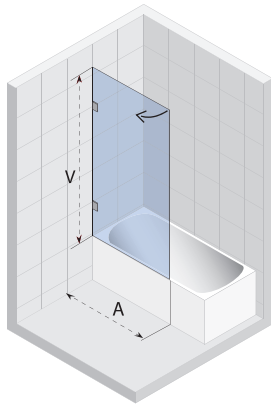

S107	A	V
GC13200	800	1500
GC15200	900	1500
GC17200	1000	1500

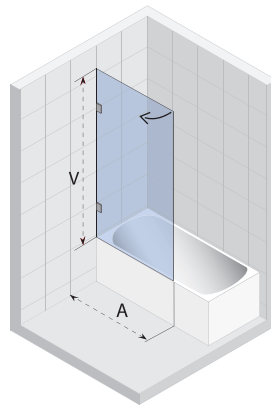

M107	L*	R*	A	V
GX010320*	1	2	800	1500
GX010520*	1	2	900	1500
GX010720*	1	2	1000	1500

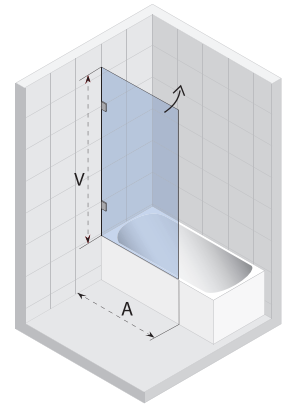

S108	A	V
GC56200	650	1500
GC57200	750	1500
GC58200	850	1500
GC59200	950	1500

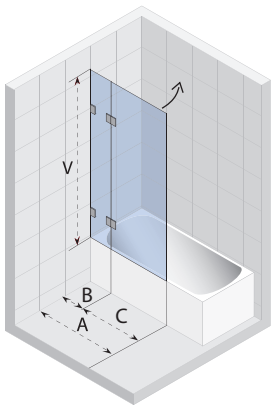

S109	A	B	C	V
GC16200	850	197	653	1500
GC19200	900	197	703	1500
GC20200	950	297	653	1500
GC21200	1000	297	703	1500

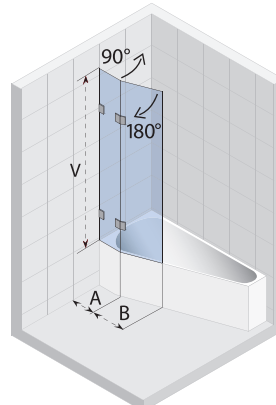

S500		A	B	V
GC60200	YUKON/NORA	820	355	1500
GC61200	GETA 160	760	355	1500
GC62200	GETA 170	860	355	1500
GC63200	DELTA 150/160	460	355	1500

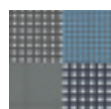
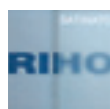
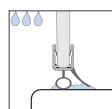
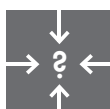

Vanové zástěny / Bathtub screens / Ванные шторки

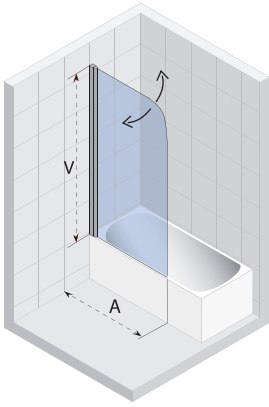

Nautic N107

	A	V
GGT0210750800	750	1500
GGT0210900800	900	1500

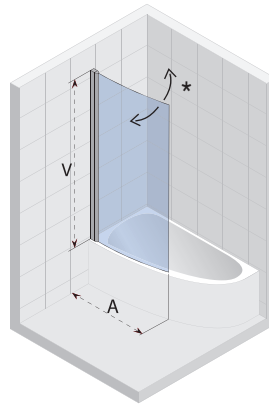

Nautic Lyra 140,153*,170

	Vana	A	V
GGT5110945800	Lyra	890	1500

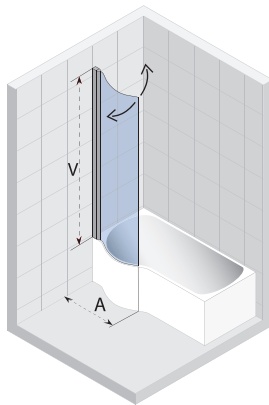

Nautic Dorado

	Vana	A	V
GGT5110776800	Dorado	776	1500

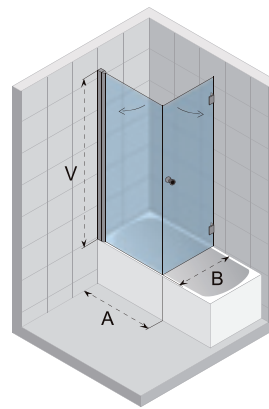

Nautic N110

		A	B	V
GHT0121650600	90x75	895 - 907	714 - 718	1500
GHT0121700600	90x80	895 - 907	764 - 768	1500
GHT0121800600	90x90	895 - 907	864 - 868	1500
GHT6121526600	Dorado	786 - 798	707 - 711	1500

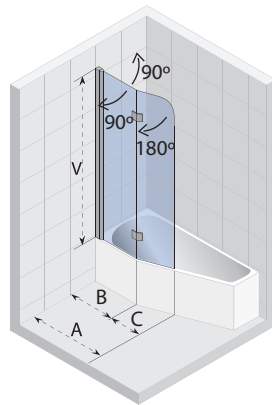
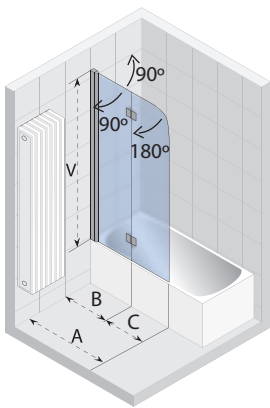

Nautic N500

	Vana	A	B	C	V
GGT0220891800	Delta 150/160	891	461	430	1500
GGT0221000800	L 1000	1000	570	430	1500
GGT0221204800	Geta 160	1204	774	430	1500
GGT0221304800	Geta 170	1304	874	430	1500
GGT0221239800	Yukon & Nora	1239	809	430	1500

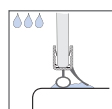

Neplatí pro Lyra 170/
not for Lyra 170/
не распространяется
на шторку для ванны
LYRA 170

* u Lyra 153 nelze sklopit dovnitř/by bathtub Lyra 153 isn't possible recline to inside/шторку для ванны LYRA 153 нельзя открывать во внутрь





THERMAE LINE

LAURA

BZ28 180 x 115 cm / 485 l

THERMAE LINE



- 2x Motor Hydro / Motor Hydro / Гидромотор
- 1x Motor Aero / Motor Aero / Аэромотор
- 6x Maxitrysky hydro / Maxi Hydro Jets / Гидро-Максифорсунки
- 12x Mikrotrysky Eyeball / Micro Jets Eyeball / Микрофорсунки Eyeball
- 19x Trysky aero / Aero Jets / Аэрофорсунки

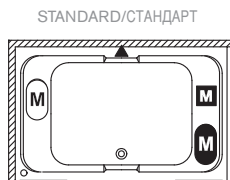
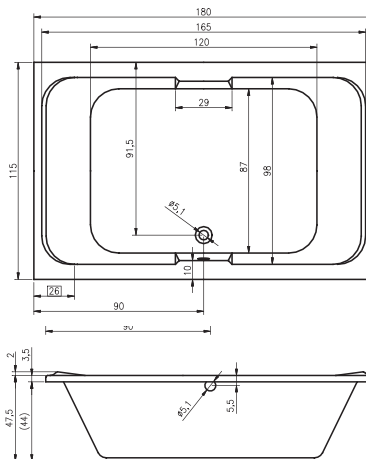

CLAUDIA

THERMAE LINE

BZ42 190 x 120 cm / 450 l



- 2x Motor Hydro / Motor Hydro / Гидромотор
- 1x Motor Aero / Motor Aero / Аэромотор
- 4x Maxitrysky hydro / Maxi Hydro Jets / Гидро-Максифорсунки
- 12x Mikrotrysky Eyeball / Micro Jets Eyeball / Микрофорсунки Eyeball
- 16x Trysky aero / Aero Jets / Аэрофорсунки

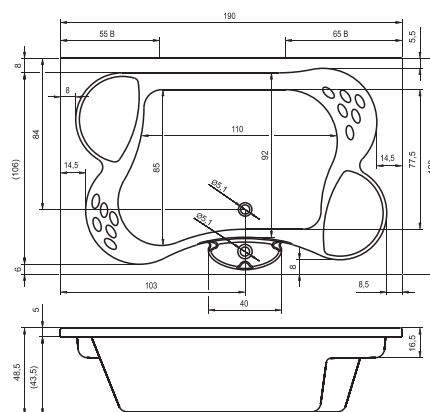
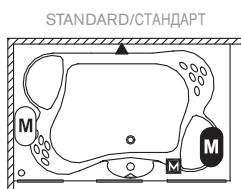

BZ15 180 x 90 cm / 355 l



- 2x Motor Hydro / Motor Hydro / Гидромотор
- 1x Motor Aero / Motor Aero / Аэромотор
- 3x Hydro trysky Spa / Hydro Jets Spa / Гидрофорсунки Spa
- 3x Hydro trysky Spa rotační / Rotating Hydro Jets Spa / Микрофорсунки вращающиеся Spa
- 4x Trysky hydro / Hydro Jets / Гидрофорсунки
- 16x Trysky aero / Aero Jets / Аэрофорсунки

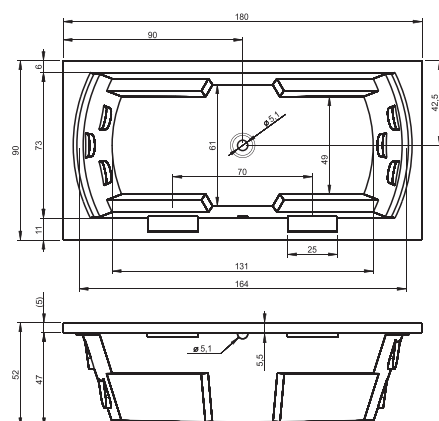

STANDARD/СТАНДАРТ

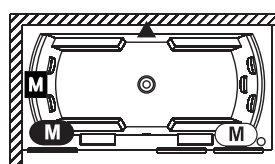

LISETTE

THERMAE LINE

BZ14 195 x 105 cm / 375 l



- 2x Motor Hydro / Motor Hydro / Гидромотор
- 1x Motor Aero / Motor Aero / Аэромотор
- 3x Hydro trysky Spa / Hydro Jets Spa / Гидрофорсунки Spa
- 3x Hydro trysky Spa rotační / Rotating Hydro Jets Spa / Микрофорсунки вращающиеся Spa
- 4x Trysky hydro / Hydro Jets / Гидрофорсунки
- 16x Trysky aero / Aero Jets / Аэрофорсунки

STANDARD/СТАНДАРТ

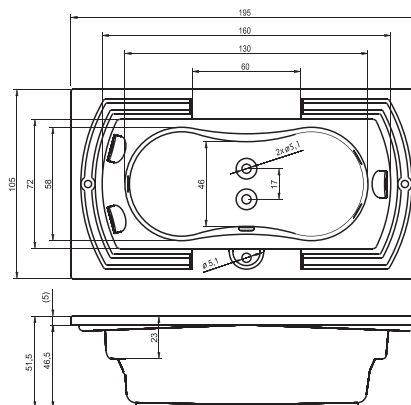
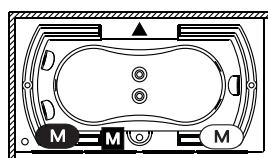

DAPHNE

BZ40 182 x 94 cm / 270 l

THERMAE LINE



- 2x Motor Hydro / Motor Hydro / Гидромотор
- 1x Motor Aero / Motor Aero / Аэромотор
- 6x Maxitrysky hydro / Maxi Hydro Jets / Гидро-Максифорсунки
- 8x Mikrotrysky Eyeball / Micro Jets Eyeball / Микрофорсунки Eyeball
- 16x Trysky aero / Aero Jets / Аэрофорсунки

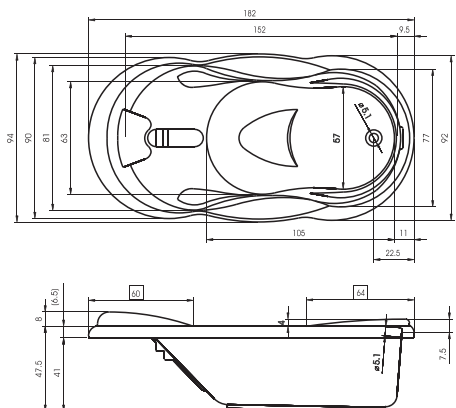

STANDARD/СТАНДАРТ

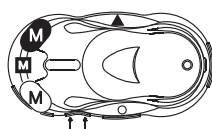

LEVÁ/LEFT/ЛЕВАЯ

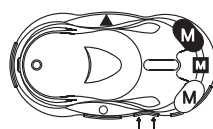

OLIVIA

BZ77 180 x 120 cm / 495 l

THERMAE LINE



- 2x Motor Hydro / Motor Hydro / Гидромотор
- 1x Motor Aero / Motor Aero / Аэромотор
- 6x Maxitrysky hydro / Maxi Hydro Jets / Гидро-Максифорсунки
- 14x Mikrotrysky / Micro Jets / Микрофорсунки
- 19x Trysky aero / Aero Jets / Аэрофорсунки

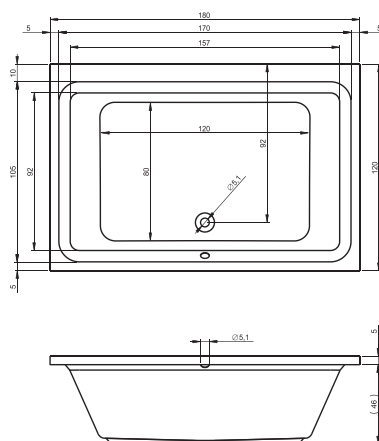
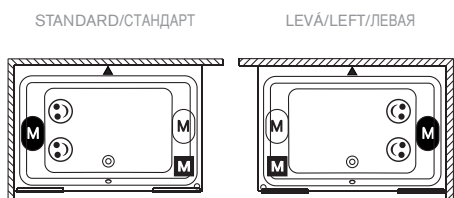

DANA

THERMAE LINE

BZ44 190 x 90 cm / 350 l



- 2x Motor Hydro / Motor Hydro / Гидромотор
- 1x Motor Aero / Motor Aero / Аэромотор
- 3x Hydro trysky Spa / Hydro Jets Spa / Гидрофорсунки Spa
- 3x Hydro trysky Spa rotační / Rotating Hydro Jets Spa / Микрофорсунки вращающиеся Spa
- 4x Trysky hydro / Hydro Jets / Гидрофорсунки
- 16x Trysky aero / Aero Jets / Аэрофорсунки

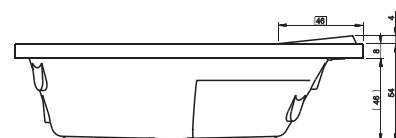
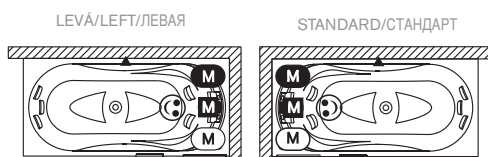
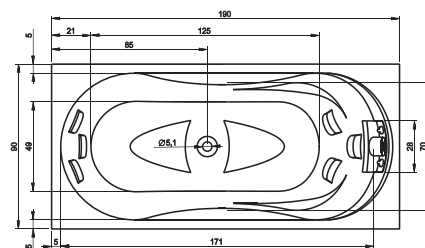

CARMEN

BZ29 Ø180 cm / 600 l

THERMAE LINE

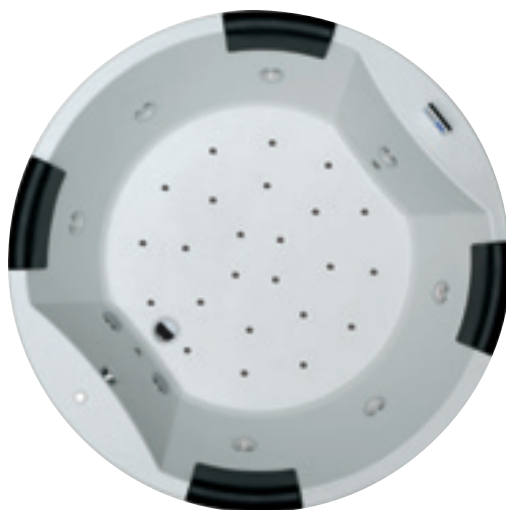

- 2x Motor Hydro / Motor Hydro / Гидромотор
- 1x Motor Aero / Motor Aero / Аэромотор
- 3x Hydro trysky Spa / Hydro Jets Spa / Гидрофорсунки Spa
- 4x Hydro trysky Spa rotační / Rotating Hydro Jets Spa / Микрофорсунки вращающиеся Spa
- 24x Trysky aero / Aero Jets / Аэрофорсунки

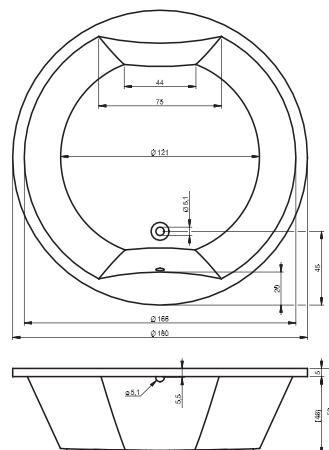
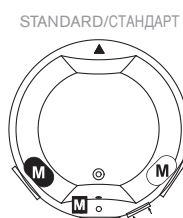

Informace/Information/Обозначения

 Automatická čistící jednotka
Cleansystem
Автоматическая система дезинфекции

 Aero
Aero system
Аэросистема

 Pulzace
Pulsation
Пульсация

 Osvětlení / Colour terapie
Light / Colour therapy
Подсветка/Хромотерапия

 Hydro
Hydro system
Гидросистема

 Volba funkcí
Function choice
Искание функцией

 Potvrzení funkce
Function confirmation
Подтверждение функций

 Volba funkcí
Function choice
Искание функцией

 MENU
MENU
МЕНЮ



Hydrotryska SPA rotační
Hydro jet SPA rotating
Гидрофорсунка SPA вращающаяся



Aero tryska
Aero jet
Аэрофорсунка



Hydrotryska SPA
Hydro jet SPA
Гидрофорсунка SPA



Mikro tryska
Micro jet
Микрофорсунка

























Maxi tryska
Maxi jet
Максифорсунка



Hydro tryska
Hydro jet
Гидрофорсунка

LCD displej / LCD display / LCD



																
Carmen	180		■	■		■			■	■ 4x	■ 2x	■ 2x	■	■	■	■
Claudia	190x120		■		■				■ 2x		■ 2x	■ 2x	■	■	■	
Daphne	182x94		■	■		■				■ 1x	■	■	■	■	■	■
Dana	190x90		■		■					■ 1x	■	■	■	■	■	■
Laura	180x115		■	■		■			■ 4x	■ 2x	■ 2x	■	■	■	■	■
Lisa	180x90		■		■		■			■ 2x	■	■	■	■	■	■
Lisette	195x105		■							■ 2x	■	■	■	■	■	■
Olivia	180x120		■	■		■			■ 4x	■ 2x	■ 2x	■	■	■	■	■

SPRCHOVÉ ZÁSTĚNY



SHOWER SCREEN / ДУШЕВЫЕ ШТОРКИ

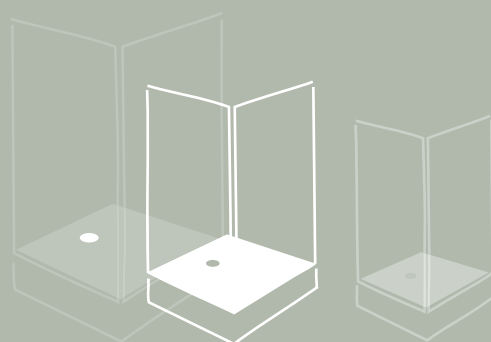

BALTIC

NEW



Sprchové zástěny/Shower screens/Душевые шторки

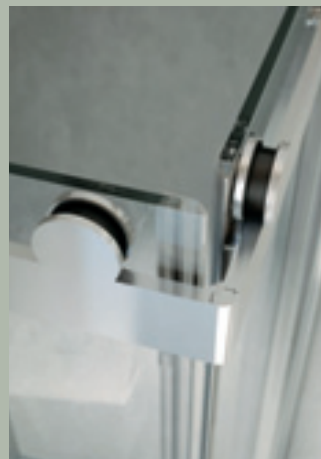

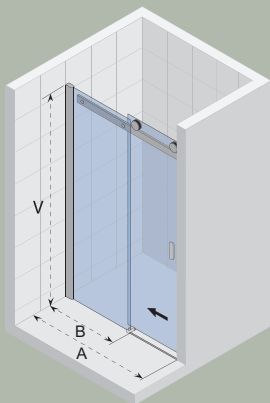

B104	Sprchová vanička (cm) Shower tray Душевой поддон			vstup entry вход	
		A	B	V	
GE0070200	100	961 - 994	480	2100	420
GE0070300	120	1161 - 1194	580	2100	520
GE0070400	140	1361 - 1394	680	2100	620
GE0070500	160	1561 - 1594	880	2100	620

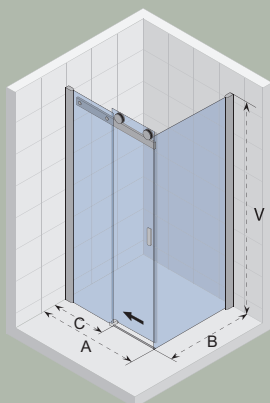

B203	Sprchová vanička (cm) Shower tray Душевой поддон				vstup entry вход	
		A	B	C	V	
GE0007200	100x80	963 - 977	763 - 777	480	2100	410
GE0902100	120x80	1163 - 1177	763 - 777	580	2100	510
GE0902300	140x80	1363 - 1377	763 - 777	680	2100	610
GE0902500	160x80	1563 - 1577	763 - 777	880	2100	610
GE0007300	100x90	963 - 977	863 - 877	480	2100	410
GE0902200	120x90	1163 - 1177	863 - 877	580	2100	510
GE0902400	140x90	1363 - 1377	863 - 877	680	2100	610
GE0902600	160x90	1563 - 1577	863 - 877	880	2100	610

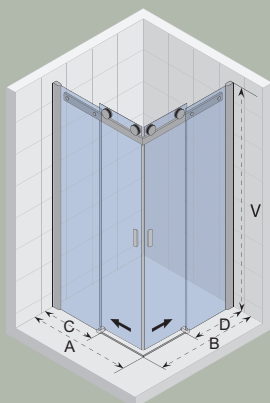

B207	Sprchová vanička (cm) Shower tray Душевой поддон					vstup entry вход	
		A	B	C	D	V	
GE1001600	80x80	763 - 777	763 - 777	330	330	2100	380
GE1001700	90x80	863 - 877	763 - 777	430	330	2100	410
GE1001800	100x80	963 - 977	763 - 777	430	330	2100	450
GE1002000	90x90	863 - 877	863 - 877	430	430	2100	450
GE1002100	100x90	963 - 977	863 - 877	430	430	2100	480
GE1002300	100x100	963 - 977	963 - 977	430	430	2100	520

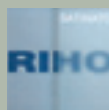
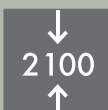
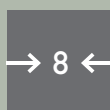
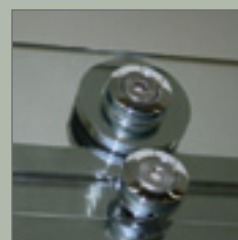

POLAR



P201

ilustrační foto/illustration photo/иллюстративное фото



P204

ilustrační foto/illustration photo/иллюстративное фото

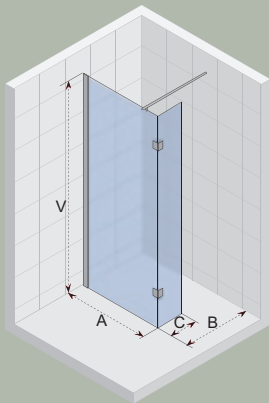

P201

Sprchová vanička (cm)
Shower tray
Душевой поддон

		A	B	C	V
GP20200	100x80 ³	965 - 975	770	270	2000
GP21200	100x90 ³	965 - 975	870	370	2000
GP26200	100x100 ³	965 - 975	970	470	2000
GP22200	120x80 ³	1165 - 1175	770	270	2000
GP23200	120x90 ³	1165 - 1175	870	370	2000
GP24200	140x90 ³	1365 - 1375	870	370	2000
GP25200	160x90 ³	1565 - 1575	870	370	2000

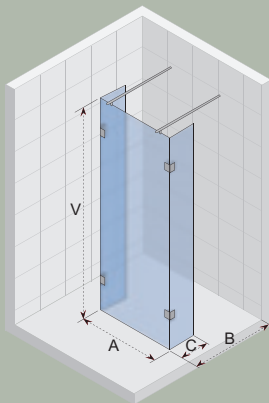
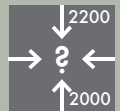

P202

Sprchová vanička (cm)
Shower tray
Душевой поддон

		A	B	C	V
GP32200	120x80 ²	1160	770	270	2000
GP33200	120x90 ²	1160	870	370	2000
GP34200	140x90 ²	1360	870	370	2000
GP35200	160x90 ²	1560	870	370	2000

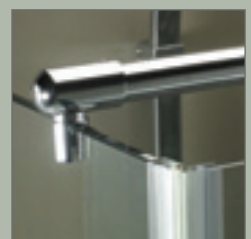
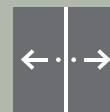
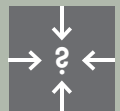

5

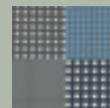
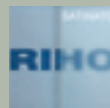
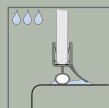
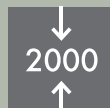
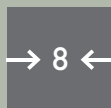

viz. str. 84/see page 84/см. стр. 84

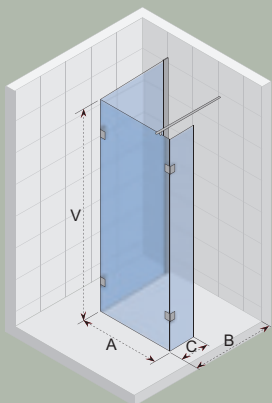

P203

Sprchová vanička (cm)
Shower tray
Душевой поддон

		A	B	C	V
GP40200	100x80 ²	960	765 - 775	270	2000
GP41200	100x90 ²	960	865 - 875	370	2000
GP46200	100x100 ²	960	965 - 975	470	2000
GP42200	120x80 ²	1160	765 - 775	270	2000
GP43200	120x90 ²	1160	865 - 875	370	2000
GP44200	140x90 ²	1360	865 - 875	370	2000
GP45200	160x90 ²	1560	865 - 875	370	2000

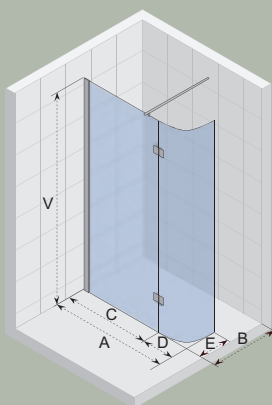
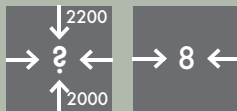

P204

Sprchová vanička (cm)
Shower tray
Душевой поддон

		A	B	C	D	E	V
GP50200	120x90 ²	1165 - 1175	870	893	277	375	2000



Příslušenství pro zástěny Polar/Accessories for screens Polar/Аксессуары для шторок Polar
131604026 - profil na podlahu/glass clip/Крепление стекла

K dodání pouze za příplatek/for extra charge only/Только за дополнительную оплату

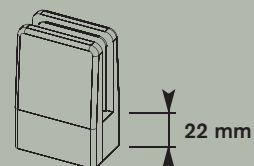

Sprchové zástěny/Shower screens/Душевые шторки

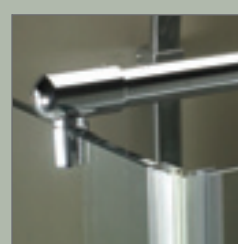
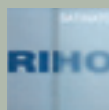
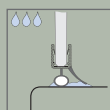
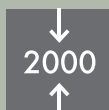

viz. str. 84/see page 84/см. стр. 84

SCANDIC



S101



S204

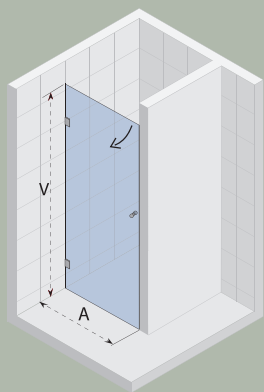

S101

Sprchová vanička (cm)
Shower tray
Душевой поддон

		A	V
GC68200	70 ²	678 - 682	2000
GC80200	80 ²	778 - 782	2000
GC01200	90 ²	878 - 882	2000
GC03200	100 ²	978 - 982	2000

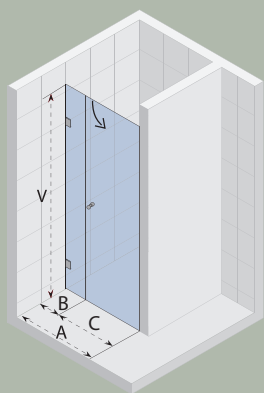

S102

Sprchová vanička (cm)
Shower tray
Душевой поддон

		A	B	C	V
GC70200	90 ²	878 - 882	216	664	2000
GC71200	100 ²	978 - 982	316	664	2000
GC72200	120 ³	1178 - 1182	516	664	2000
GC73200	140 ³	1378 - 1382	716	664	2000
GC74200	160 ³	1578 - 1582	916	664	2000

5

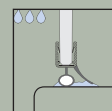
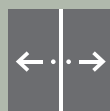
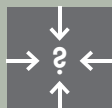
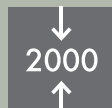

viz. str. 84/see page 84/см. стр. 84

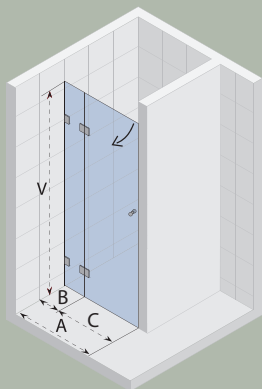

S104 Sprchová vanička (cm)
Shower tray
Душевой поддон

		A	B	C	V
GC04200	80 ²	778 - 782	197	583	2000
GC05200	90 ²	878 - 882	197	683	2000
GC07200	100 ²	978 - 982	297	683	2000
GC07300	120 ²	1178 - 1182	497	683	2000
GC07400	140 ²	1378 - 1382	697	683	2000
GC07500	160 ²	1578 - 1582	897	683	2000

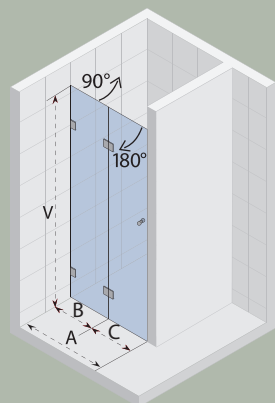

S105 Sprchová vanička (cm)
Shower tray
Душевой поддон

		A	B	C	V
GC08200	80 ²	778 - 782	384	396	2000
GC09200	90 ²	878 - 882	434	446	2000
GC11200	100 ²	978 - 982	484	496	2000

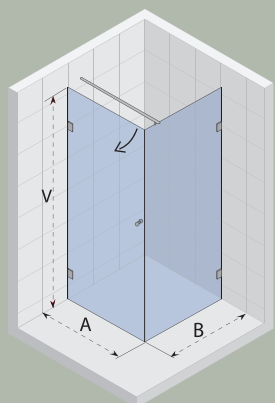

S201 Sprchová vanička (cm)
Shower tray
Душевой поддон

		A	B	V
GC22200	80x80 ³	768 - 772	768 - 772	2000
GC22400	80x90 ³	768 - 772	868 - 872	2000
GC23100	90x80 ³	868 - 872	768 - 772	2000
GC23200	90x90 ³	868 - 872	868 - 872	2000
GC24200	100x80 ³	968 - 972	768 - 772	2000
GC26200	100x90 ³	968 - 972	868 - 872	2000
GC25200	100x100 ³	968 - 972	968 - 972	2000

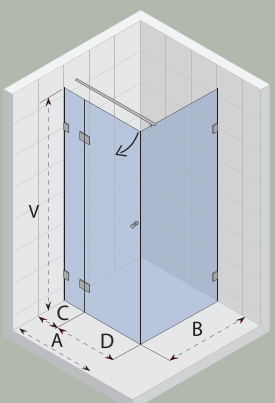

S203 Sprchová vanička (cm)
Shower tray
Душевой поддон

		A	B	C	D	V
GC91200	80x80 ³	768 - 772	768 - 772	197	573	2000
GC27200	90x90 ³	868 - 872	868 - 872	197	673	2000
GC28200	100x80 ³	968 - 972	768 - 772	297	673	2000
GC90200	100x90 ³	968 - 972	868 - 872	297	673	2000
GC29200	100x100 ³	968 - 972	968 - 972	297	673	2000
GC92100	120x80 ⁴	1168 - 1172	768 - 772	497	673	2000
GC92200	120x90 ⁴	1168 - 1172	868 - 872	497	673	2000
GC92400	140x90 ⁵	1368 - 1372	868 - 872	697	673	2000
GC92600	160x90 ⁵	1568 - 1572	868 - 872	897	673	2000
GC92800	180x90 ⁵	1768 - 1772	868 - 872	897	873	2000

Umístění stabilizačních tyčí se liší dle rozměrů sprchové zástěny.
Fixing rod is placed according to dimensions of the shower enclosure.
Размещение стабилизирующего стержня зависит от размеров душевой перегородки.

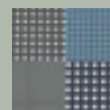
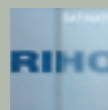
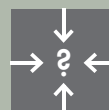
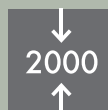
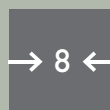
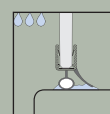
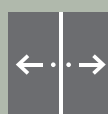

viz. str. 84/see page 84/см. стр. 84

- 2 bez stabilizační tyče/without fixing rod/без стабилизирующего стержня
- 3 standardní stabilizační tyč/standard fixing rod/стабилизирующих стержня, délka 102,5 cm/length 102,5 cm/длина 102,5
- 4 standardní stabilizační tyč/standard fixing rod/стабилизирующих стержня, délka 120 cm/length 120 cm/длина 120 cm, + T-kus/T-part/T-část
- 5 standardní stabilizační tyč/standard fixing rod/стабилизирующих стержня, délka 160 cm/length 160 cm/длина 160 cm, + T-kus/T-part/T-část
- 6 2x standardní stabilizační tyč/standard fixing rod/стабилизирующих стержня, délka 102,5 cm/length 102,5 cm/длина 102,5 cm, + T-kus/T-part/T-část

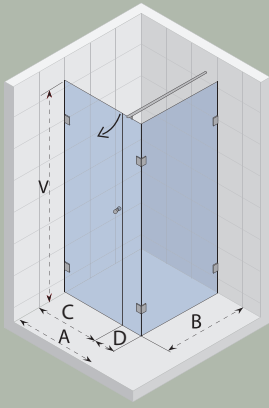

S204 Sprchová vanička (cm)
Shower tray
Душевой поддон

		A	B	C	D	V
GC81200	80x80 ²	768 - 772	768 - 772	564	206	2000
GC82200	90x90 ²	868 - 872	868 - 872	664	206	2000
GC82700	100x80 ²	968 - 972	768 - 772	664	306	2000
GC83200	100x90 ²	968 - 972	868 - 872	664	306	2000
GC85200	100x100 ²	968 - 972	968 - 972	664	306	2000
GC85700	120x80 ³	1168 - 1172	768 - 772	664	506	2000
GC84200	120x90 ³	1168 - 1172	868 - 872	664	506	2000
GC84700	140x90 ³	1368 - 1372	868 - 872	664	706	2000
GC86200	160x90 ³	1568 - 1572	868 - 872	664	906	2000

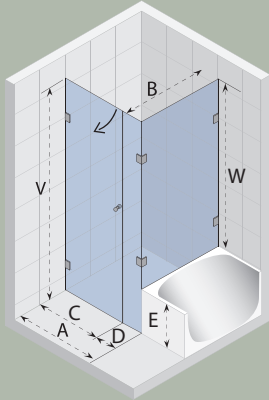

S208 Sprchová vanička (cm)
Shower tray
Душевой поддон

		A ¹	B	C	D	E	V	W
GC33200	90x90 ²	878 - 882	868 - 872	664	216	400	2000	1600

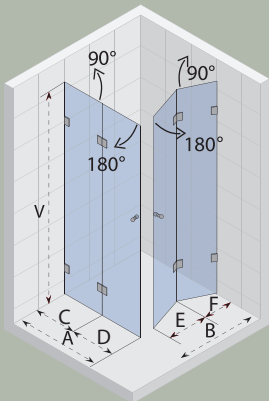

S211 Sprchová vanička (cm)
Shower tray
Душевой поддон

		A	B	C	D	E	F	V
GC34200	80x80 ²	768 - 772	768 - 772	385	385	385	385	2000
GC35200	90x90 ²	868 - 872	868 - 872	435	435	435	435	2000
GC36200	100x80 ²	968 - 972	768 - 772	485	485	385	385	2000
GC38200	100x90 ²	968 - 972	868 - 872	485	485	435	435	2000
GC37200	100x100 ²	968 - 972	968 - 972	485	485	485	485	2000

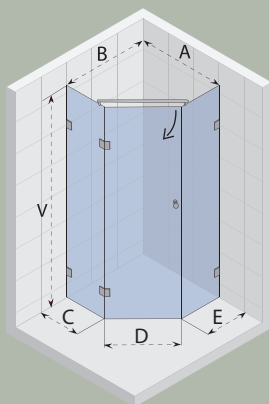

S301 Sprchová vanička (cm)
Shower tray
Душевой поддон

		A	B	C	D	E	V
GC40200	90x90 ⁴	868 - 872	868 - 872	382	690	382	2000
GC42200	100x100 ⁴	968 - 972	968 - 972	482	690	482	2000

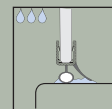
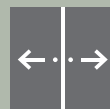
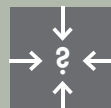
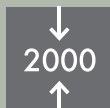
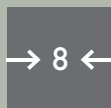

viz. str. 84/see page 84/см. стр. 84

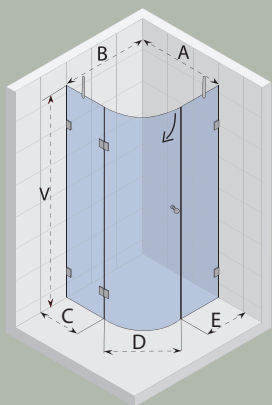

S308 Sprchová vanička (cm)
Shower tray
Душевой поддон

		A	B	C	D	E	V
GC44200	90x90; r=55 ^s	868 - 872	868 - 872	332	750	332	2000
GC46200	100x100; r=55 ^s	968 - 972	968 - 972	432	750	432	2000
GC47200	120x120; r=55 ^s	1168 - 1172	1168 - 1172	632	750	632	2000

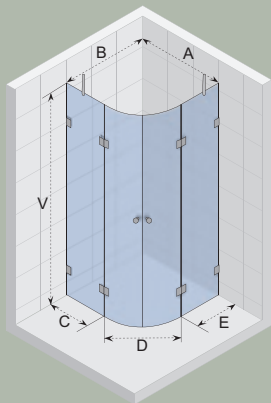

oblé sklo/bended glass/круглое остекло



S309 Sprchová vanička (cm)
Shower tray
Душевой поддон

		A	B	C	D	E	V
GC44300	90x90; r=55 ^s	868 - 872	868 - 872	332	750	332	2000
GC46300	100x100; r=55 ^s	968 - 972	968 - 972	432	750	432	2000
GC47300	120x120; r=55 ^s	1168 - 1172	1168 - 1172	632	750	632	2000

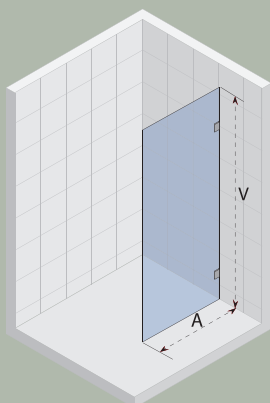

S400 Sprchová vanička (cm)
Shower tray
Душевой поддон

		A	V
GC49200	80 ²	748 - 752	2000
GC50200	90 ²	848 - 852	2000
GC52200	100 ²	948 - 952	2000
GC51200	120 ³	1148 - 1152	2000
GC53200	140 ³	1348 - 1352	2000
GC54200	160 ³	1548 - 1552	2000

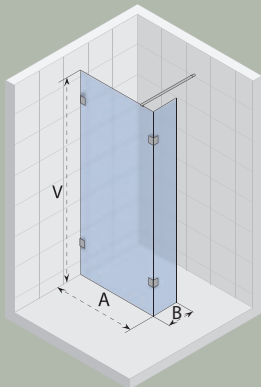

S402 Sprchová vanička (cm)
Shower tray
Душевой поддон

		A	B	V
GC75200	100 ³	968 - 972	292	2000
GC76200	100 ³	1068 - 1072	292	2000
GC77200	120 ³	1168 - 1172	292	2000
GC78200	140 ³	1368 - 1372	292	2000
GC79200	160 ³	1568 - 1572	292	2000

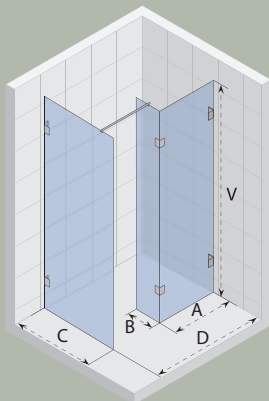

S405

	A	B	C	D	V
GC94200	768 - 772	292	848 - 852	max 1770	2000
GC95200	868 - 872	292	848 - 852	max 1870	2000
GC96200	968 - 972	292	848 - 852	max 1970	2000
GC97200	1068 - 1072	292	848 - 852	max 2070	2000

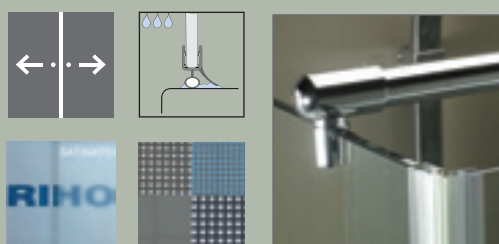

viz. str. 84/see page 84/см. стр. 84

SCANDIC WALL



W203



W400

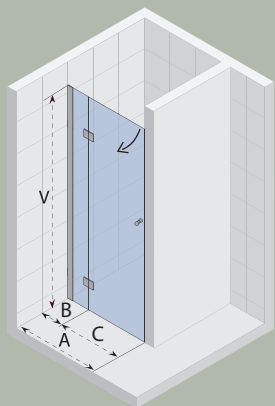

W104 Sprchová vanička (cm)
Shower tray
Душевой поддон

		A	B	C	V
GW05200	90°	875 - 885	197	683	2000
GW11200	100°	975 - 985	297	683	2000
GW12200	120°	1175 - 1185	497	683	2000
GW13200	140°	1375 - 1385	697	683	2000
GW14200	160°	1575 - 1585	897	683	2000

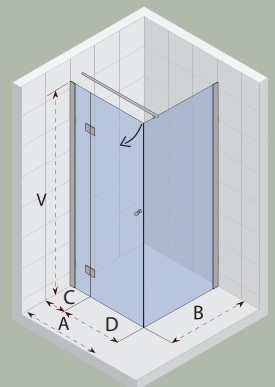

W203 Sprchová vanička (cm)
Shower tray
Душевой поддон

		A	B	C	D	V
GW27200	90x90°	865 - 875	865 - 875	197	673	2000
GW28200	100x80°	965 - 975	765 - 775	297	673	2000
GW90200	100x90°	965 - 975	865 - 875	297	673	2000
GW29200	100x100°	965 - 975	965 - 975	297	673	2000
GW92200	120x90°	1165 - 1175	865 - 875	497	673	2000

Umístění stabilizačních tyčí se liší dle rozměrů sprchové zástěny.
Fixing rod is placed according to dimensions of the shower enclosure.
Размещение стабилизирующего стержня зависит от размеров душевой перегородки.

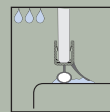
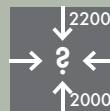
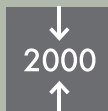

viz. str. 84/see page 84/см. стр. 84

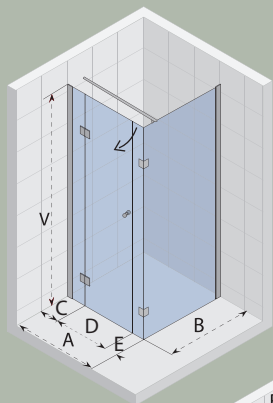

W205

Sprchová vanička (cm)
Shower tray
Душевой поддон

		A	B	C	D	E	V
GW30200	120x80 ⁶	1165 - 1175	765 - 775	230	710	230	2000
GW31200	120x90 ⁶	1165 - 1175	865 - 875	230	710	230	2000
GW32200 ⁷	140x90 ⁷	1365 - 1375	865 - 875	330	710	330	2000
GW33200 ⁷	160x90 ⁷	1565 - 1575	865 - 875	430	710	430	2000

Umístění stabilizačních tyčí se liší dle rozměrů sprchové zástěny.

Fixing rod is placed according to dimensions of the shower enclosure.

Размещение стабилизирующего стержня зависит от размеров душевой перегородки.

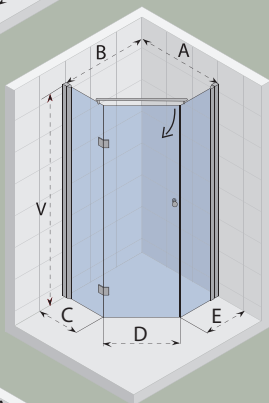

W301

Sprchová vanička (cm)
Shower tray
Душевой поддон

		A	B	C	D	E	V
GW40200	90x90 ⁴	865 - 875	865 - 875	382	690	382	2000
GW42200	100x100 ⁴	965 - 975	965 - 975	482	690	482	2000

oblé sklo/bended glass/круглое остекло

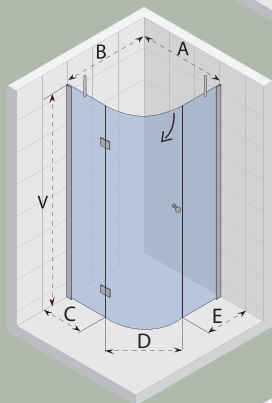

W308

Sprchová vanička (cm)
Shower tray
Душевой поддон

		A	B	C	D	E	V
GW44200	90x90; r=55 ⁵	865 - 875	865 - 875	332	750	332	2000
GW46200	100x100; r=55 ⁵	965 - 975	965 - 975	432	750	432	2000
GW47200	120x120; r=55 ⁵	1165 - 1175	1165 - 1175	632	750	632	2000



oblé sklo/bended glass/круглое остекло

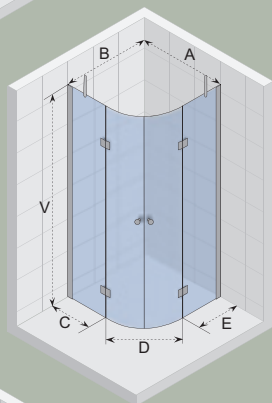

W309

Sprchová vanička (cm)
Shower tray
Душевой поддон

		A	B	C	D	E	V
GW44300	90x90; r=55 ⁵	865 - 875	865 - 875	332	750	332	2000
GW46300	100x100; r=55 ⁵	965 - 975	965 - 975	432	750	432	2000
GW47300	120x120; r=55 ⁵	1165 - 1175	1165 - 1175	632	750	632	2000

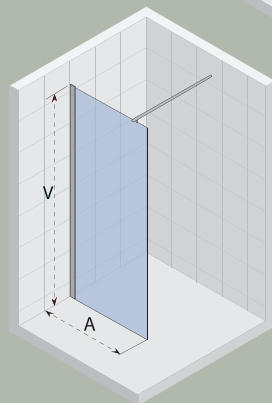

W400

Sprchová vanička (cm)
Shower tray
Душевой поддон

		A	V
GW49200	80 ²	745 - 755	2000
GW50200	90 ²	845 - 855	2000
GW52200	100 ²	945 - 955	2000
GW51200	120 ³	1145 - 1155	2000

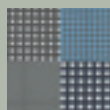
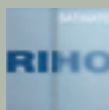
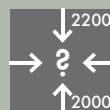
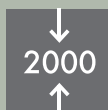
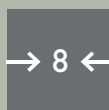
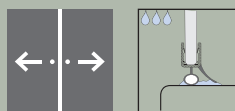

viz. str. 84/see page 84/см. стр. 84

2 bez stabilizační tyče/without fixing rod/без стабилизирующего стержня

3 standardní stabilizační tyč/standard fixing rod//стабилизирующих стержня, délka 102,5 cm/length 102,5 cm/длина 102,5 cm

4 stabilizační tyč k zástěně/fixing rod for shower screen/стабилизирующий стержень к перегородке W301

5 2x stabilizační tyč 45°/2x fixing rod 45°/стабилизирующих стержня 45°

6 standardní stabilizační tyč/standard fixing rod//стабилизирующих стержня, délka 120 cm/length 120 cm/длина 120 cm

7 standardní stabilizační tyč/standard fixing rod//стабилизирующих стержня, délka 160 cm/length 160 cm/длина 160 cm, + T-kus/T-part/Т-часть

SCANDIC LIFT - Mistral



M201



M203

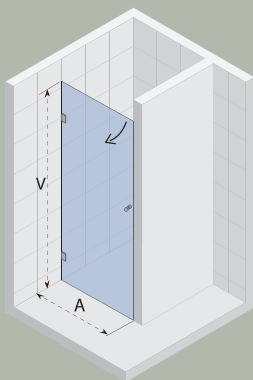

M101

Sprchová vanička (cm)

Shower tray
Душевой поддон

	*L	*R		A	V
GX060820*	1	2	70°	678 - 682	2000
GX080020*	1	2	80°	778 - 782	2000
GX000120*	1	2	90°	878 - 882	2000
GX000320*	1	2	100°	978 - 982	2000



Levý
Left
Левый



Pravý
Right
Правый

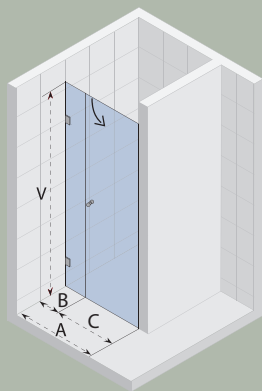

M102

Sprchová vanička (cm)

Shower tray
Душевой поддон

	L*	R*		A	B	C	V
GX070200*	1	2	90°	878 - 882	216	664	2000
GX071200*	1	2	100°	978 - 982	316	664	2000
GX072200*	1	2	120°	1178 - 1182	516	664	2000
GX073200*	1	2	140°	1378 - 1382	716	664	2000
GX074200*	1	2	160°	1578 - 1582	916	664	2000



Levý
Left
Левый

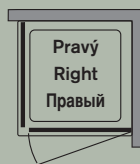

Pravý
Right
Правый

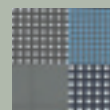
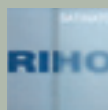
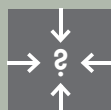
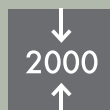
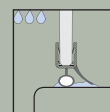

viz. str. 84/see page 84/см. стр. 84

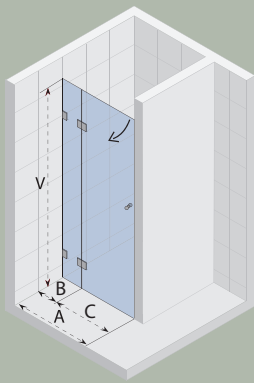

M104

Sprchová vanička (cm)
Shower tray
Душевой поддон

	*L	*R		A	B	C	V
GX004020*	1	2	80°	768 - 772	197	573	2000
GX008020*	1	2	90°	878 - 882	197	683	2000
GX007020*	1	2	100°	978 - 982	297	683	2000
GX007030*	1	2	120°	1178 - 1182	497	683	2000
GX007040*	1	2	140°	1378 - 1382	697	683	2000
GX007050*	1	2	160°	1578 - 1582	897	683	2000

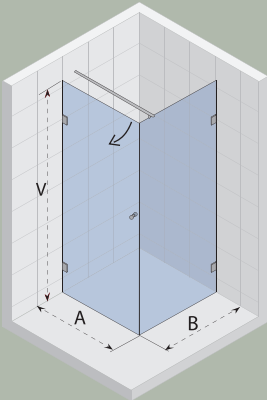
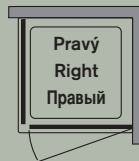

M201

Sprchová vanička (cm)
Shower tray
Душевой поддон

	*L	*R		A	B	V
GX020220*	1	2	80x80°	768 - 772	768 - 772	2000
GX020240*	1	2	80x90°	768 - 772	868 - 872	2000
GX020310*	1	2	90x80°	868 - 872	768 - 772	2000
GX020320*	1	2	90x90°	868 - 872	868 - 872	2000
GX020420*	1	2	100x80°	968 - 972	768 - 772	2000
GX020620*	1	2	100x90°	968 - 972	868 - 872	2000
GX020520*	1	2	100x100°	968 - 972	968 - 972	2000

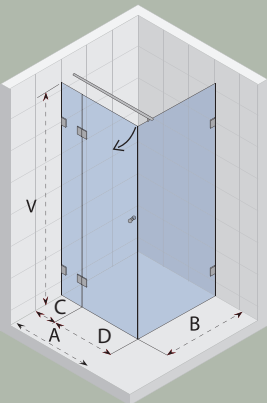
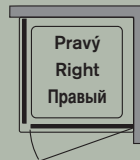

M203

Sprchová vanička (cm)
Shower tray
Душевой поддон

	*L	*R		A	B	C	D	V
GX000420*	1	2	80x80°	768 - 772	768 - 772	197	573	2000
GX000520*	1	2	90x90°	868 - 872	868 - 872	197	673	2000
GX000720*	1	2	100x80°	968 - 972	768 - 772	297	673	2000
GX000730*	1	2	100x90°	968 - 972	868 - 872	297	673	2000
GX000740*	1	2	100x100°	968 - 972	968 - 972	297	673	2000
GX090210*	1	2	120x80°	1168 - 1172	768 - 772	497	673	2000
GX090220*	1	2	120x90°	1168 - 1172	868 - 872	497	673	2000
GX090240*	1	2	140x90°	1368 - 1372	868 - 872	697	673	2000
GX090260*	1	2	160x90°	1568 - 1572	868 - 872	897	673	2000
GX090280*	1	2	180x90°	1768 - 1772	868 - 872	897	873	2000

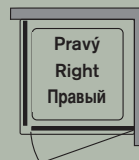

Umístění stabilizačních tyčí se liší dle rozměrů sprchové zástěny.
Fixing rod is placed according to dimensions of the shower enclosure.
Размещение стабилизирующего стержня зависит от размеров душевой перегородки.

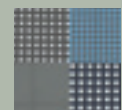
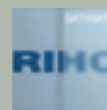
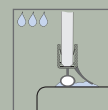
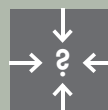
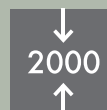
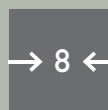

viz. str. 84/see page 84/см. стр. 84

- 2 bez stabilizační tyče/without fixing rod/без стабилизирующего стержня
- 3 standardní stabilizační tyč/standard fixing rod/стабилизирующих стержня, délka 102,5 cm/length 102,5 cm/длина 102,5 cm
- 4 standardní stabilizační tyč/standard fixing rod/стабилизирующих стержня, délka 120 cm/length 120 cm/длина 120 cm, + T-kus/T-part/Т-часть
- 5 standardní stabilizační tyč/standard fixing rod/стабилизирующих стержня, délka 160 cm/length 160 cm/длина 160 cm, + T-kus/T-part/Т-часть
- 6 2x standardní stabilizační tyč/standard fixing rod/стабилизирующих стержня, délka 102,5 cm/length 102,5 cm/длина 102,5 cm, + T-kus/T-part/Т-часть

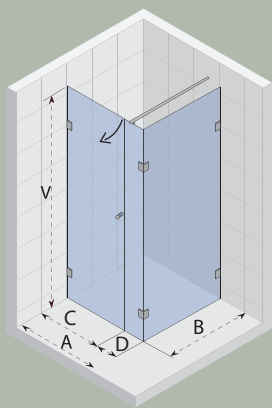

M204

			Sprchová vanička (cm) Shower tray Душевой поддон					
	*L	*R	A	B	C	D	V	
GX080120*	1	2	80x80 ²	768 - 772	768 - 772	564	206	2000
GX080220*	1	2	90x90 ²	868 - 872	868 - 872	664	206	2000
GX080270*	1	2	100x80 ²	968 - 972	768 - 772	664	306	2000
GX080320*	1	2	100x90 ²	968 - 972	868 - 872	664	306	2000
GX080520*	1	2	100x100 ²	968 - 972	968 - 972	664	306	2000
GX080570*	1	2	120x80 ³	1168 - 1172	768 - 772	664	506	2000
GX080420*	1	2	120x90 ³	1168 - 1172	868 - 872	664	506	2000
GX080470*	1	2	140x90 ³	1368 - 1372	868 - 872	664	706	2000
GX080620*	1	2	160x90 ³	1568 - 1572	868 - 872	664	906	2000

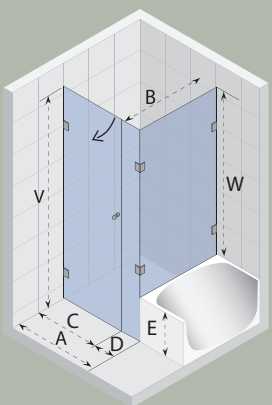
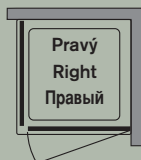

M208

			Sprchová vanička (cm) Shower tray Душевой поддон							
	L*	R*	A ¹	B	C	D	E	V	W	
GX030320*	1	2	90x90 ²	878 - 882	868 - 872	664	216	400	2000	1600

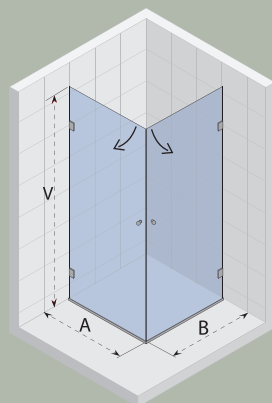

M209

	Sprchová vanička (cm) Shower tray Душевой поддон			
	A	B	V	
GX1202200	80x80 ²	768 - 772	768 - 772	2000
GX1207200	90x80 ²	868 - 872	768 - 772	2000
GX1203200	90x90 ²	868 - 872	868 - 872	2000
GX1204200	100x80 ²	968 - 972	768 - 772	2000
GX1206200	100x90 ²	968 - 972	868 - 872	2000
GX1205200	100x100 ²	968 - 972	968 - 972	2000

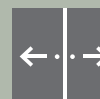

viz. str. 84/see page 84/см. стр. 84

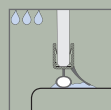
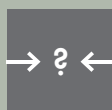
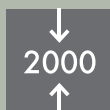
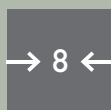

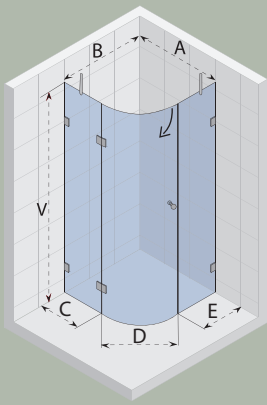

M308

	*L	*R	Sprchová vanička (cm) Shower tray Душевой поддон	A	B	C	D	E	V
GX040420*	1	2	90x90; r=55 ⁷	868 - 872	868 - 872	332	750	332	2000
GX040620*	1	2	100x100; r=55 ⁷	968 - 972	968 - 972	432	750	432	2000
GX040720*	1	2	120x120; r=55 ⁷	1168 - 1172	1168 - 1172	632	750	632	2000

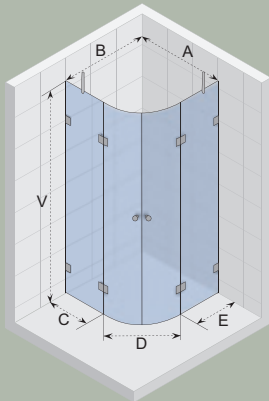

M309

	A	B	C	D	E	V	
GX0440300	90x90; r=55 ⁷	868 - 872	868 - 872	332	750	332	2000
GX0460300	100x100; r=55 ⁷	968 - 972	968 - 972	432	750	432	2000
GX0470300	120x120; r=55 ⁷	1168 - 1172	1168 - 1172	632	750	632	2000

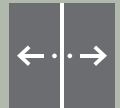

Formulář pro atypické provedení SCANDIC umístěn
na www.riho.com

Form for atypical SCANDIC showers green placed on
www.riho.com

Форма для нестандартного исполнения шторки SCANDIC
www.riho.com

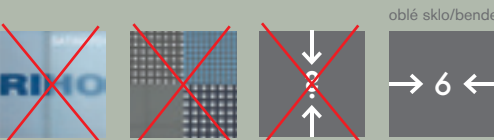

oblé sklo/bended glass/круглое остекло

viz. str. 84/see page 84/см. стр. 84

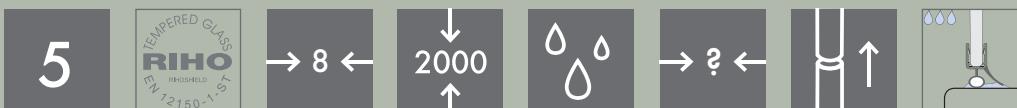

FJORD



F203



F308

F203

Sprohová vanička (cm)
Shower tray
Душевой поддон

	A	B	C	D	E	F	V
90x90	853-868	853-868	305	565	565	305	2000
100x100	953-968	953-968	405	565	565	405	2000
120x120	1153-1168	1153-1168	605	565	565	605	2000
Příklad asymetrického provedení							
100x90	953-968	853-868	405	565	565	305	2000
120x90	1153-1168	853-868	605	565	565	305	2000
120x100	1153-1168	953-968	605	565	565	405	2000

Vstup/Entry/Проход = 76 cm

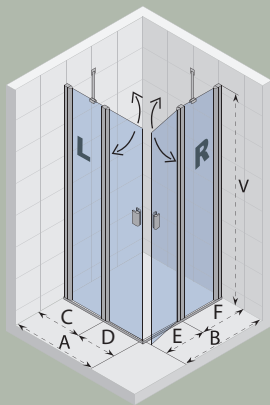

GFB0304801	Fjord čtverec/square/квадрат 860x2000	levá/left/левая
L GFB0305801	Fjord čtverec/square/квадрат 960x2000	levá/left/левая
GFB0307801	Fjord čtverec/square/квадрат 1160x2000	levá/left/левая
GFB0304802	Fjord čtverec/square/квадрат 860x2000	pravá/right/правая
R GFB0305802	Fjord čtverec/square/квадрат 960x2000	pravá/right/правая
GFB0307802	Fjord čtverec/square/квадрат 1160x2000	pravá/right/правая

Lze kombinovat různé rozměry levé a pravé části.

5

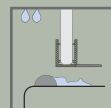
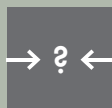
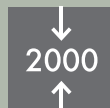

FJORD

F308

Sprchová vanička (cm)
Shower tray
Душевой поддон

	A	B	C	D	E	F	V
90x90; r=55	855-870	855-870	320	550	550	320	2000
100x100; r=55	955-970	955-970	420	550	550	420	2000
120x120; r=55	1155-1170	1155-1170	620	550	550	620	2000
Příklad asymetrického provedení							
100x90; r=55	955-970	855-870	420	550	550	320	2000
120x90; r=55	1155-1170	855-870	620	550	550	320	2000
120x100; r=55	1155-1170	955-970	620	550	550	420	2000

Vstup/Entry/Проход = 76 cm

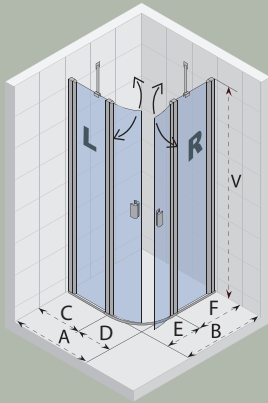

GFB0204801	Fjord čtvrtkruh/quadrant/квадрант	860x2000	levá/left/левая
L GFB0205801	Fjord čtvrtkruh/quadrant/квадрант	960x2000	levá/left/левая
GFB0207801	Fjord čtvrtkruh/quadrant/квадрант	1160x2000	levá/left/левая
GFB0204802	Fjord čtvrtkruh/quadrant/квадрант	860x2000	pravá/right/правая
R GFB0205802	Fjord čtvrtkruh/quadrant/квадрант	960x2000	pravá/right/правая
GFB0207802	Fjord čtvrtkruh/quadrant/квадрант	1160x2000	pravá/right/правая

Lze kombinovat různé rozměry levé a pravé části.



Sprchové zástěny/Shower screens/Душевые шторы

5

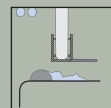
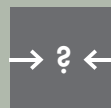
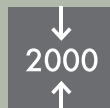

FJORD / NAUTIC

COMBI

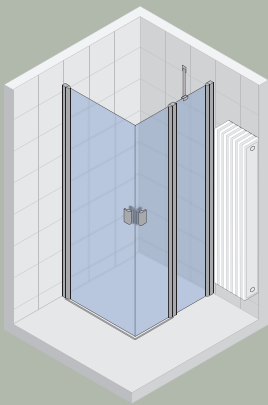

Nautic čtverec/square/квадрант
Fjord čtverec/square/квадрант

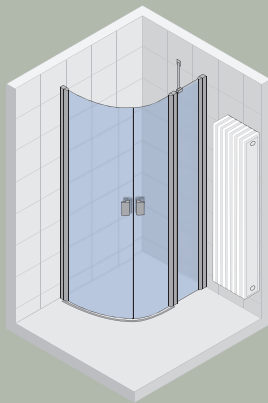

Nautic čtvrtkruh/quadrant/квадрант
Fjord čtvrtkruh/quadrant/квадрант

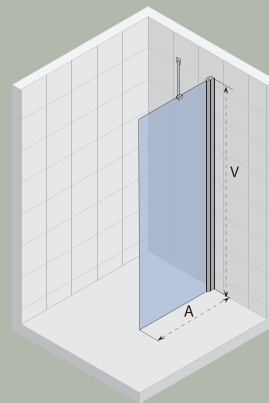

combi	Sprchová vanička (cm) Shower tray Душевой поддон		A	V
	90	100		
GGB0904800	90	855 - 869	2000	
GGB0905800	100	955 - 969	2000	

Doplňky/Option/Дополнительное оборудование

sedátko černé/seat - black/черное сидение

vybavení za příplatek / option /опция

rozměry / size / размер 36x35 cm

nosnost / maximum load / Максимальный вес 130 kg

Nesmí být použito pro porobetonové zdi/

it can not be used for aerconcecrete walls/

Не разрешается использовать для пенобетонových стен

Fjord / Nautic Fixed Wall/

Фиксируемая стена Fjord

Možnost kombinovat s Fjord

- dveře do niky/possible combination
with fjord nika door/

Возможные положения двери Fjord



Sedátko bez opěrky/Seat without back/Сидение без спинки
AS02110



Sedátko s opěrkou/Seat with back/Сидение со спинкой AS02115

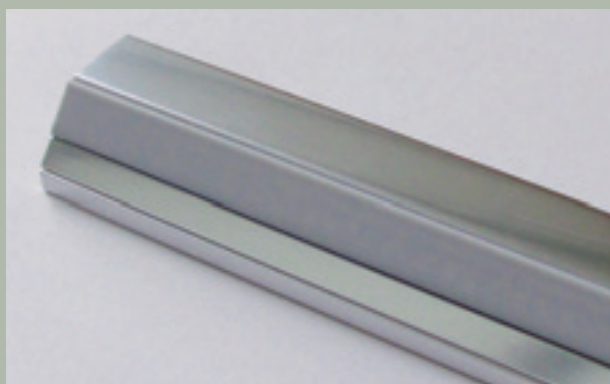

Bez rozšiřovacího profilu/without extender profile/
Без расширительного профиля

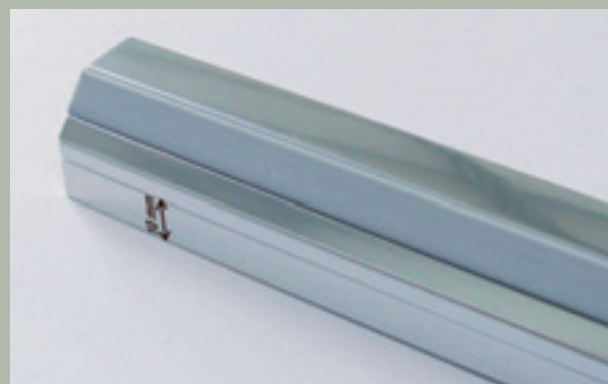

Rozšiřovací profil/Extender Profile/Регулирующий профиль
160108925

10 mm extra pomocí nabízeného profilu/
extra 10mm by offered profile/

Увеличивает ширину профиля на 10 мм

Lze použít pro N101, S101, M101, S104, M104, W104, S105
Possible to used by N101, S101, M101, S104, M104, W104, S105
можно использовать N101, S101, M101, S104, M104, W104, S105

FJORD - pevná stěna/Walk In/Прходная шторка



ilustrační foto/illustration photo/иллюстративное фото

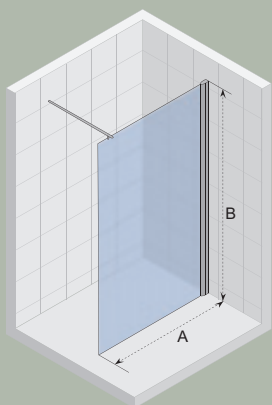

F400'

Sprchová vanička (cm)
Shower tray
Душевой поддон

		A	V
GFB0105800	100	963-977	2000
GFB0107800	120	1163-1177	2000
GFB0108800	140	1363-1377	2000
GFB0109800	160	1563-1577	2000

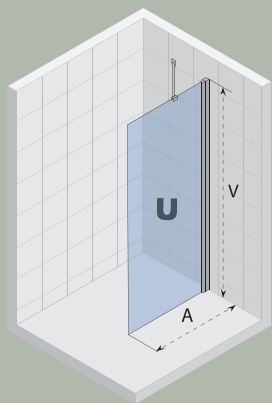

F401

Sprchová vanička (cm)
Shower tray
Душевой поддон

		A	V
GFB0002800	80	763-777	2000
GFB0004800	90	863-877	2000
GFB0005800	100	963-977	2000



Sprchové zástěny/Shower screens/Душевые шторки

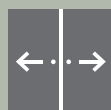
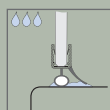
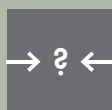
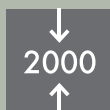



NAUTIC



N101



N111

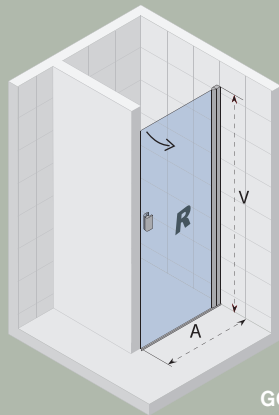
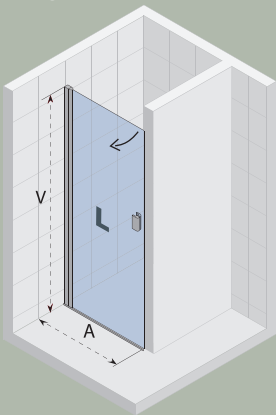

N101

Sprchová vanička (cm)
Shower tray
Душевой поддон

	A	V
70	676-696	2000
80	776-796	2000
90	876-896	2000
100	976-996	2000

- GGB0600801 Nautic dveře do niky/nika door 680x2000 levá/left/левая
- L GGB0602801 Nautic dveře do niky/nika door 780x2000 levá/left/левая
- GGB0604801 Nautic dveře do niky/nika door 880x2000 levá/left/левая
- GGB0605801 Nautic dveře do niky/nika door 980x2000 levá/left/левая
- GGB0600802 Nautic dveře do niky/nika door 680x2000 pravá/right/правая
- R GGB0602802 Nautic dveře do niky/nika door 780x2000 pravá/right/правая
- GGB0604802 Nautic dveře do niky/nika door 880x2000 pravá/right/правая
- GGB0605802 Nautic dveře do niky/nika door 980x2000 pravá/right/правая

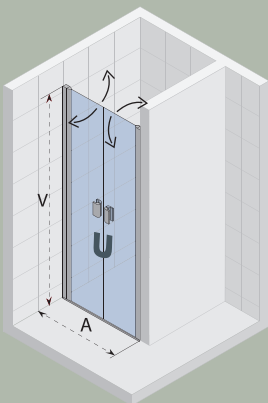

N111

Sprchová vanička (cm)
Shower tray
Душевой поддон

	A	V
80	772-792	2000
90	872-892	2000
100	972-992	2000

- GGB0802800 Nautic Swing 780x2000 Univers.
- GGB0804800 Nautic Swing 880x2000 Univers.
- GGB0805800 Nautic Swing 980x2000 Univers.

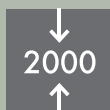

NAUTIC



N209



N308

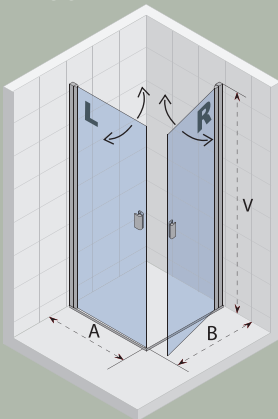

N209

Sprchová vanička (cm)
Shower tray
Душевой поддон

	A	B	V
80x80	757-767	757-767	2000
90x90	857-867	857-867	2000
100x100	957-967	957-967	2000
Příklad asymetrického provedení			
90x80	857-867	757-767	2000
100x80	957-967	757-767	2000
100x90	957-967	857-867	2000

GGB0302801	Nautic čtverec square/квадрат	760x2000	levá left/левая
L GGB0304801	Nautic čtverec square/квадрат	860x2000	levá left/левая
GGB0305801	Nautic čtverec square/квадрат	960x2000	levá left/левая
GGB0302802	Nautic čtverec square/квадрат	760x2000	pravá right/правая
R GGB0304802	Nautic čtverec square/квадрат	860x2000	pravá right/правая
GGB0305802	Nautic čtverec square/квадрат	960x2000	pravá right/правая

Lze kombinovat různé rozměry levé a pravé části.
It is possible to combine various dimensione of L/R part
Можно комбинировать различные размеры левых и правых частей

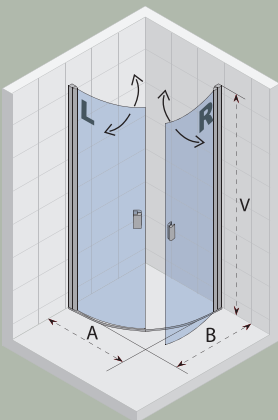

N308

Sprchová vanička (cm)
Shower tray
Душевой поддон

	A	B	V
90x90; r=55	858-868	858-868	2000

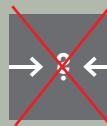

L GGB0204801	Nautic čtvrtkruh quadrant/квадрант	860x2000	levá left/левая
R GGB0204802	Nautic čtvrtkruh quadrant/квадрант	860x2000	pravá right/правая

5

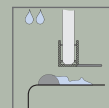

LUCENA

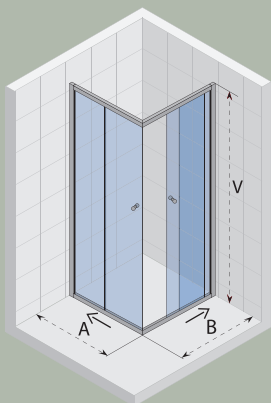

Čtverec/Square/Квадрат

	Sprchová vanička (cm) Shower tray Душевой поддон	A	B	V	vstup entry вход
GK32200	80x80	783 - 803	783 - 803	1950	420
GK34200	90x90	883 - 903	883 - 903	1950	420
GK36200	100x100	983 - 1003	983 - 1003	1950	520

Díl s dveřmi Door part Дверная часть

	A	V
GKB32200 ²	783 - 803	1950
GKB34200 ²	883 - 903	1950
GKB36200 ²	983 - 1003	1950
GKB38200 ²	1183 - 1203	1950

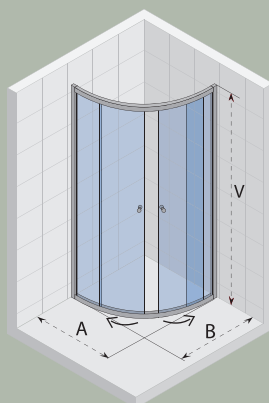

Čtvrtek R 55 cm/Quadrant/Квадрат

	Sprchová vanička (cm) Shower tray Душевой поддон	A	B	V	vstup entry вход
GK22200	80x80; r=55	783 - 803	783 - 803	1950	400
GK24200	90x90; r=55	883 - 903	883 - 903	1950	540
GK26200	100x100; r=55	983 - 1003	983 - 1003	1950	540
GK12200	90x90; r=55	883 - 903	883 - 903	1500	540

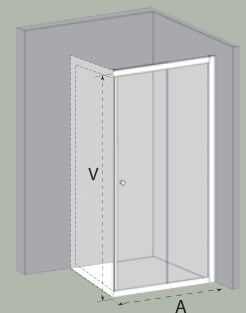

Sprchové zástěny/Shower screens/Душевые шторы

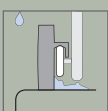
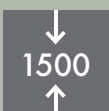
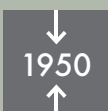
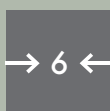

HAMAR

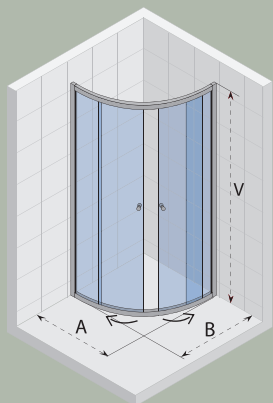

Sprchový kout Shower enclosure Душевой уголок	Rozměr (cm) Dimensions (cm) Размер (cm)	A	B	V	vstup entry вход
GR32200	quadrant/квадрант 80x80; r=55	770 - 805	770 - 805	1950	480
GR33200	quadrant/квадрант 90x90; r=55	870 - 905	870 - 905	1950	500
GR35200	quadrant/квадрант 100x100; r=55	970 - 1005	970 - 1005	1950	500

Výška 195cm, čiré bezpečnostní sklo 6mm, posuvné dveře, profil Al –pochromovaný
 Height 195cm, glass-safety-thickness 6mm, sliding doors, profile colour chrome
 Высота 195см, прозрачное безопасное стекло 6 мм, раздвижные двери, профиль хромированный

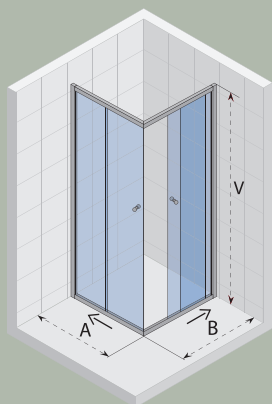

Sprchový kout Shower enclosure Душевой угол	Rozměr (cm) Dimensions (cm) Размер (cm)	A	B	V	vstup entry вход
GR53200	čtverec/square/квadrat 80x80	770 - 805	770 - 805	1950	410
GR54200	čtverec/square/квadrat 90x90	870 - 905	870 - 905	1950	480
GR56200	čtverec/square/квadrat 100x100	970 - 1005	970 - 1005	1950	480



2

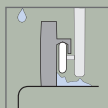
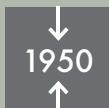

LUCENA

komplet/set/комплект

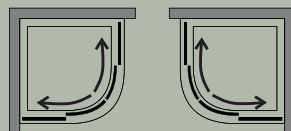

kód/code/код GSET021 90x90x202 cm; R 55
 vanička s podpěrami a panelem/
 shower tray incl. props and front panel/
 поддон с опорами и панелью DB 43
 zástěna/shower screen/шторка LUCENA
 (výška/height/высота 150 cm)

profil Al - pochromovaný.
 profile color chrome.
 профиль Al - хромированный.

Bezpečnostní sklo 6 mm – sklo, posuvné dveře, profil Al - pochromovaný
 Glass safety, thickness 6 mm – glass, sliding doors, profile colour chrome
 Безопасное стекло 6 мм – стекло, раздвижные двери, белый профиль Al - хромированный



ilustrační foto/illustration photo/иллюстративное фото

POTISK SKLA SPRCHOVÝCH ZÁSTĚŇ, SATINATO

(SCANDIC, POLAR, BALTIC) Nutno udat L/P provedení

SHOWER SCREENS WITH PRINTED GLASS, SATINATO

(SCANDIC, POLAR, BALTIC) Necessary to specify L/P

ДУШЕВЫЕ ШТОРКИ С ПЕЧАТНЫМ ДЕКОРОМ, SATINATO

(SCANDIC, POLAR, BALTIC) НЕОБХОДИМО УТОЧНИТЬ: ЛЕВОЕ ИЛИ ПРАВОЕ ИСПОЛНЕНИЕ L/P



Možnosti potisku skel/Printed Glass/Образцы декора на стекле

DEKOR 1
ДЕКОР 1

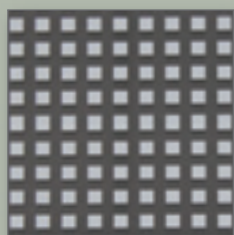

DEKOR 2
ДЕКОР 2

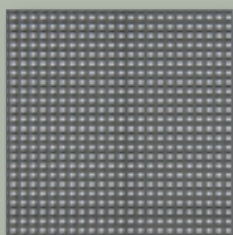

DEKOR 3
ДЕКОР 3

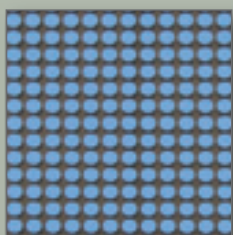

DEKOR 4
ДЕКОР 4

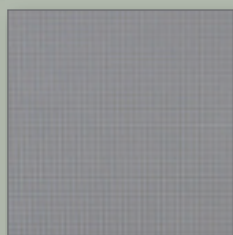

DEKOR 5
ДЕКОР 5

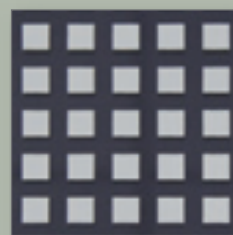

Potisk skla u sprchových zástěň Scandic a Polar. Potisk, ani provedení satinato nelze provést u zástěň P204, S308, W308, M308, S309, W309, M309.

Printed glass is offered at shower screens Scandic and Polar – Printing and Satinato except P204, S308, W308, M308, S309, W309, M309.

Предлагаем для душевых шторок серии Скандик (Scandic) и Полар (Polar), Печатный декор на молочное стекло (SATINATO) нельзя у шторок P204, S308, W308, M308, S309, W309, M309.

DEKOR 1 ДЕКОР 1

velikost vzoru: 8x8 mm
mezera: 7 mm
hustota tisku: 30%
printing density: 30%

размер рисунка 8 x 8 мм
промежуток 7 мм
плотность печати 30%

DEKOR 2 ДЕКОР 2

vzor: Ø 3 mm
mezera: 2,5 mm
hustota tisku: 28%
printing density: 28%

рисунок Ø 3 мм
промежуток 2,5 мм
плотность печати 28%

DEKOR 3 ДЕКОР 3

vzor: Ø 8 mm
mezera: 2 mm
hustota tisku: 30%
printing density: 30%

рисунок Ø 8 мм
промежуток 2 мм
плотность печати 30%

DEKOR 4 ДЕКОР 4

vzor: Ø 1,5 mm
mezera: 1,5 mm
hustota tisku: 78%
printing density: 78%





рисунок Ø 1,5 мм
промежуток 1,5 мм
плотность печати 78%

DEKOR 5 ДЕКОР 5

velikost vzoru: 15x15 mm
mezera: 10 mm
hustota tisku: 25%
printing density: 25%

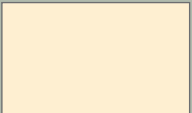
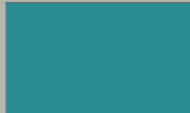
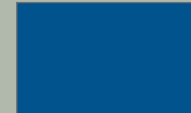
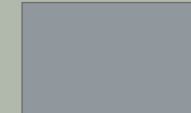
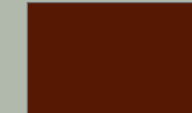
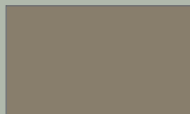
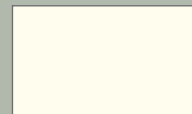
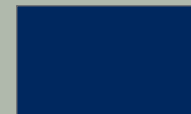
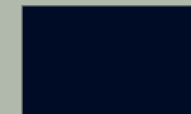
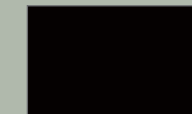
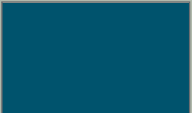
размер рисунка 15 x 15 мм
промежуток 10 мм
плотность печати 25%

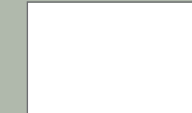
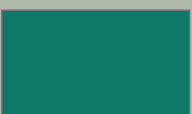
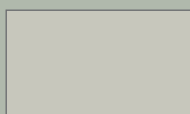
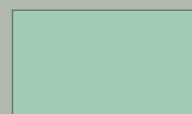
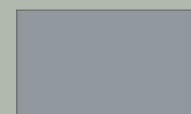
Vzorník barev RAL/Colour card RAL/Цветовая палитра RAL

<p>ústřicově bílá Oyster white Перламутрово-белый</p>  <p>1013</p>	<p>mint Mint Мята</p>  <p>6033</p>	<p>signální hnědá Signal brown Сигнальный коричневый</p>  <p>8002</p>	<p>jasně modrá Brilliant blue Ярко-синий</p>  <p>5007</p>	<p>stříbrno-šedá Silver grey Серебристо-серый</p>  <p>7001</p>	<p>čokoládově hnědá Chocolate brown Шоколадно-коричневый</p>  <p>8017</p>
<p>světle modrá Light blue Голубой</p>  <p>5012</p>	<p>popelavě hnědá Moss grey Пепельно-коричневый</p>  <p>7033</p>	<p>signální bílá Signal white Сигнальный белый</p>  <p>9003</p>	<p>kobaltová modř Cobalt blue Синий кобальт</p>  <p>5013</p>	<p>antracitová Anthracite grey Серый антрацит</p>  <p>7016</p>	<p>signální černá Signal black Сигнальный черный</p>  <p>9004</p>
<p>námořní modrá Ocean blue Цвет морской волны</p>  <p>5020</p>	<p>šedá – granit Granite grey Серый гранит</p>  <p>7024</p>	<p>černá Black Черный</p>  <p>141001-černá</p>	<p>pastelově modrá Pastel blue Пастельный голубой</p>  <p>5024</p>	<p>modro-šedá Blue grey Сине-серый</p>  <p>7031</p>	<p>bílá White Белый</p>  <p>194011-bílá</p>
<p>zastřená zelená Patina green Зеленая патина</p>  <p>6000</p>	<p>světle šedá Light grey Светло-серый</p>  <p>7035</p>	<p>pastelově zelená Pastel green Пастельный zelený</p>  <p>6019</p>	<p>šedá Window grey Серый</p>  <p>7040</p>	<p>opálově zelená Opal green Зеленый опал</p>  <p>6026</p>	<p>tmavě šedá Traffic grey Темно-серый</p>  <p>7043</p>

Zobrazené odstíny barev RAL nemusí přesně odpovídat originálu z důvodu odlišného vnímání vytištěného vzorníku barev.
Painted colour shade RAL need not exactly correspond with original, because of the different colour perception of the printed colour card.
Изображенные оттенки цветов RAL не должны точно соответствовать оригиналу в силу различия в восприятии печатной палитры цветов



Vysvětlivky/Information/Обозначения

2

2 roky záruka
2 years guarantee
Гарантия 2 года

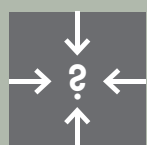

Možné atypické provedení (šířka, výška)
Customised version possible (Width, Height)
Возможность нестандартного исполнения (ширина, высота)

5

5 let záruka na sklo
5 years guarantee on glass
Гарантия 5 лет на стекло

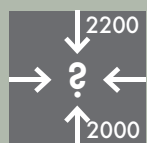

Možné atypické provedení (šířka, výška)
Výška zástěny 2000/ 2200 mm
Customised version possible (Width, Height)
Height of the shower screen 2000/ 2200 mm
Возможность нестандартного исполнения (ширина, высота) Высота шторки 2000 мм/2200 мм



Povrchová úprava RIHO Shield
RIHO Shield surface finish
Поверхностная обработка RIHO Shield

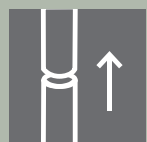

Samozvedací pant
Lifting hinge
Самоподнимающая петл

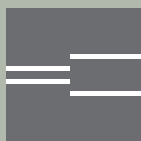

Rozšiřující profil
Extended profile
Расширительный профиль

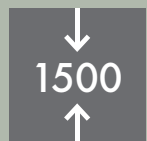

Výška zástěny 1500 mm
Height of the shower screen 1500 mm
Высота шторки 1500 мм

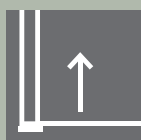

Samozvedací profil
Lifting profile
Самоподнимающийся профиль

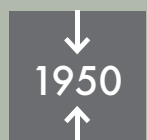

Výška zástěny 1950 mm
Height of the shower screen 1950 mm
Высота шторки 1950 мм

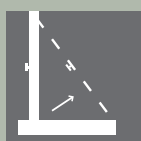

Snadné čištění pomocí vysazení pojezdu skla
Easy cleaning thanks to system move out
Простота очистки путём демонтажа профиля для движения стекла

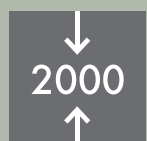

Výška zástěny 2000 mm
Height of the shower screen 2000 mm
Высота шторки 2000 мм



Kalené sklo dle normy EN 12150-1
Safety glass according to standard EN 12150-1
Закаленное стекло в соответствии с нормой EN 12150-1

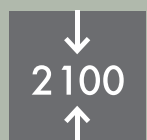

Výška zástěny 2100 mm
Height of the shower screen 2100 mm
Высота шторки 2100 мм

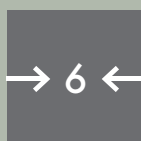

Tloušťka skla 6 mm
Thickness of the safety glass 6 mm
Толщина стекла 6 мм

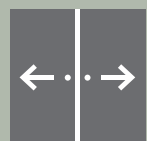

Univerzální zástěna pro levé i pravé provedení
Universal shower screen for right and left execution
Универсальный правый и левый вариант входа

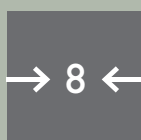

Tloušťka skla 8 mm
Thickness of the safety glass 8 mm
Толщина стекла 8 мм

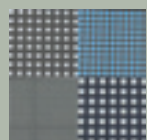

Možnost potisku skla
Printed glass
Возможность печати стекла

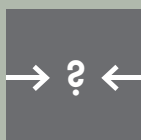

Možné atypické provedení (šířka)
Customised version possible (Width)
Возможность нестандартного исполнения (ширина)

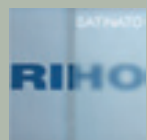

Mléčné sklo Satinato (za příplatek)
Frosted glass Satinato (for extra charge)
Молочное стекло Satinato (надбавка)

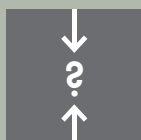

Možné atypické provedení (výška)
Customised version possible (Height)
Возможность нестандартного исполнения (высота)

Informace/Information/Обозначения

Těsnost sprchových zástěn

Všechny sprchové zástěny firmy RIHO jsou testovány dle obvyklých standardů na těsnost proti unikající vodě. Celé řešení sprchových zástěn je provedeno takovým způsobem, aby se minimalizovalo množství úniku vody. Zástěny jsou při běžném užívání odolné proti stříkající vodě. Drobný průnik vody je možný a není závadou výrobku. Stupeň těsnosti zástěn je dán označením.

Tightness of shower screens

All RIHO's shower screens are tested according to usual standards for water tightness. The entire shower screen is designed in such a way as to minimize the amount of water leakage. In normal use, the screens are splash-proof. Mild water penetration is possible and is not a product defect. The screen tightness level is indicated.

Герметичность душевых перегородок

Все душевые перегородки производства фирмы RIHO тестируются в соответствии с принятыми стандартами на герметичность протечки воды. Общее решение душевых перегородок осуществлено таким образом, чтобы свести к минимуму протечки воды. При обычном пользовании перегородки препятствуют разбрызгиванию воды. Мелкие протечки возможны, но не считаются дефектом данного изделия. Степень герметичности соответствует принятому обозначению.

Stupně těsnosti zástěn

Screen tightness levels

Степень герметичности душевых перегородок

Stupeň I.

Sprchové zástěny s obvodovým rámem poskytují nejvyšší stupeň těsnosti proti stříkající a stékající vodě.

Level I.

Shower screens having a peripheral frame provide the highest degree of tightness against splashing or running water.

Степень I.

Душевые перегородки с контурным профилем обеспечивают максимальную герметичность от разбрызгивания и стекания воды.

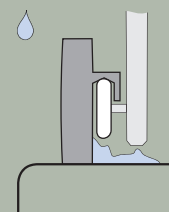

Stupeň II.

Sprchové zástěny s plochým těsněním a prahovou lištou poskytují dobrou těsnost proti stříkající a stékající vodě, kde prahová lišta vytváří bariéru proti úniku vody ze sprchového koutu.

Level II.

Shower screens with flat gasket and sill moulding provide a good seal against splashing or running water. The sill moulding forms a barrier against leakage of water out of the shower.

Степень II.

Душевые перегородки с плоским уплотнением и профилем порожка обеспечивают хорошую герметичность от разбрызгивания и стекания воды, профиль порожка при этом служит в качестве барьера для предотвращения протечки воды из душевой кабины.

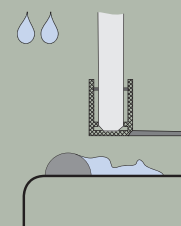

Stupeň III.

Sprchové zástěny s těsněním pomocí dvou těsnících ploch poskytují dostatečnou ochranu proti stékající vodě. U těchto zástěn je vše podmíněno absolutní čistotě designu.

Level III

The shower screens sealed by two sealing surfaces provide sufficient protection against running water. In case of these screens everything is subject to the absolute purity of design.

Степень III.

Душевые перегородки с уплотнением, создаваемым двумя уплотнительными поверхностями, что обеспечивает достаточную защиту от стекания воды. У таких перегородок всё подчинено абсолютной чистоте дизайна.

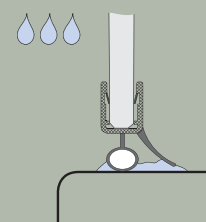

Příslušenství/Accessories/Аксессуары



AT10125 Pojezdová tyč čtvercová mosaz chromovaná
AT10125 Sliding bar square shape brass/chrome plated
AT10125 Подвижная квадратная штанга латунь хромированная

AT20125 Hlavová sprcha nerez ocel chromovaná 30x30 cm G1/2
AT20125 Headshower stainless steel chrome plated 30x30 cm G1/2
AT20125 Головной душ - нержавеющая сталь хромированная 30 x 30 cm G1/2

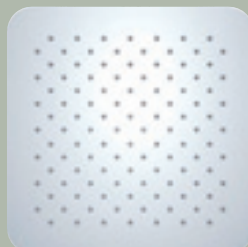
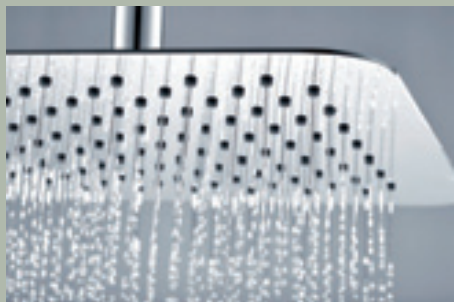

AT22125 Hlavová sprcha nerez ocel chromovaná 30x30 cm G1/2
AT22125 Headshower stainless steel chrome plated 30x30 cm G1/2
AT22125 Головной душ - нержавеющая сталь хромированная 40 x 40 cm G1/2

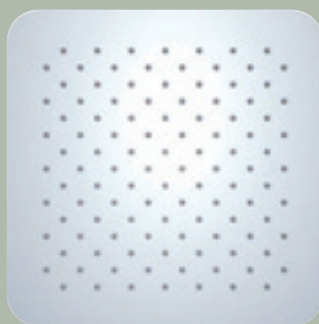

Příslušenství/Accessories/Аксессуары



AT30125 Držák stropní hlavové sprchy kulatý mosaz chromovaná 200 mm
AT30125 Headshower plafond wall bar brass round chrome plated 200 mm
AT30125 Держатель потолочный головного душа – круглый, латунь хромированная 200 мм

AT32125 Držák horizontální hlavové sprchy kulatý mosaz chromovaná 400 mm
AT32125 Headshower wall bar brass round chrome plated 400 mm
AT32125 Держатель горизонтальный головного душа – круглый, латунь хромированная 400 мм



AT34125 Držák horizontální hlavové sprchy kulatý mosaz chromovaná 500 mm
AT34125 Headshower wall bar brass round chrome plated 500 mm
AT34125 Держатель горизонтальный головного душа – круглый, латунь хромированная 500 мм



AT40125 Držák stropní hlavové sprchy čtvercový mosaz chromovaná 200 mm
AT40125 Headshower plafond bar brass square chrome plated 200 mm
AT40125 Держатель потолочный головного душа – квадратный, латунь хромированная 200 мм

AT42125 Držák horizontální hlavové sprchy čtvercový mosaz chromovaná 400 mm
AT42125 Headshower wall bar brass square chrome plated 400 mm
AT42125 Держатель горизонтальный головного душа – квадратный, латунь хромированная 400 мм

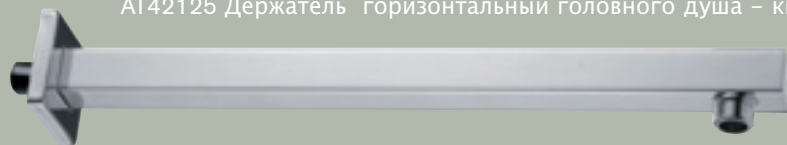

AT44125 Držák horizontální hlavové sprchy čtvercový mosaz chromovaná 500 mm
AT44125 Headshower wall bar brass square chrome plated 500 mm
AT44125 Держатель горизонтальный головного душа – квадратный, латунь хромированная 500 мм

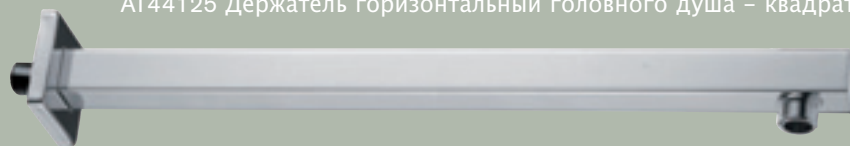

AT50125 Ruční sprcha nastavitelná chrom/bílá plast
AT50125 Headshower adjustable chrome/white plastic
AT50125 Ручной душ настраиваемый - комбинация хром/белый пласт

LITÝ MRAMOR/SYNTETIC MARBLE/ЛИТОЙ МРАМОР

Sprchové vaničky KOLPING jsou dodávány včetně podpěr a výpustí.
KOLPING shower trays are supplied with legs and discharge.
Душевые поддоны KOLPING поставляются только в комплекте с подставками и водоспуском.

Výška sifonu 80 mm. / Siphon height 80 mm. / Высота сифона 80 мм.

DB10 80 x 80 cm



P10 panel/cover



DB14 90 x 90 cm



P14 panel/cover



DB18 100 x 100 cm



P18 panel/cover

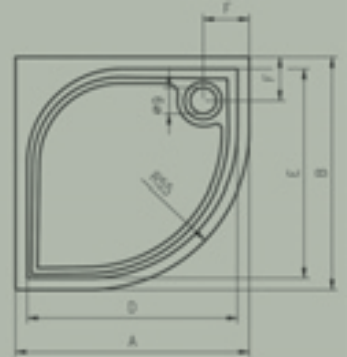

DB20 80 x 80 cm



P20 panel/cover

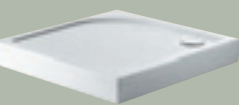

DB21 90 x 90 cm



P21 panel/cover

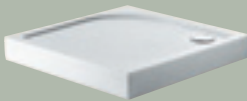

DB 31 100 x 80 cm

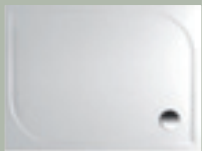

P31 panel R/cover R

P32 panel L/cover L



DB32 100 x 90 cm



P35 panel R/cover R

P36 panel L/cover L

DB34 120 x 90 cm

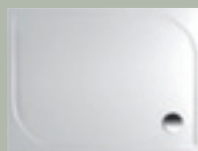

P37 panel R/cover R

P38 panel L/cover L

DB36 140 x 90 cm

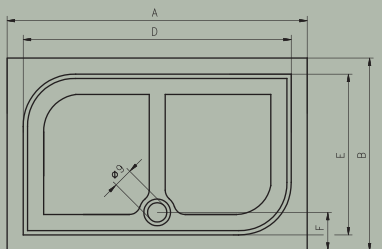

DB33 120 x 80 cm



P33 panel R/cover R

P34 panel L/cover L

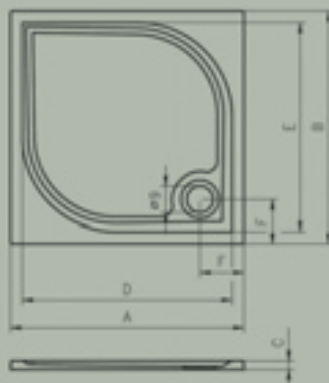

model	A (cm)	B (cm)	C (cm)	D (cm)	E (cm)	F (cm)
DB 10	80	80	3	72	72	15
DB 14	90	90	3	82	82	18,5
DB 18	100	100	3	92	92	18,5
DB 20	80	80	3	72	72	15
DB 21	90	90	3	82	82	18,5
DB 31	100	80	3	92	72	15,5
DB 32	100	90	3	92	82	18,5
DB 33	120	80	3	112	72	15
DB 34	120	90	3	105	75	19
DB 36	140	90	3	125	75	18

výška panelu 9,5 cm / height of panel 9.5 cm

AKRYL/ACRYL/АКРИЛ

248 80 x 80 x 4,5

249* 80 x 80 x 14

250 90 x 90 x 4,5

251* 90 x 90 x 14

260 100 x 100 x 4,5

261* 100 x 100 x 14

252 100 x 90 x 4,5

253* 100 x 90 x 14

254 120 x 90 x 4,5

255* 120 x 90 x 14

256 140 x 90 x 4,5

257* 140 x 90 x 14

258 160 x 90 x 4,5

259* 160 x 90 x 14

276 180 x 90 x 5

270 90 x 80 x 4,5

271* 90 x 80 x 14

272 100 x 80 x 4,5

273* 100 x 80 x 14

274 120 x 80 x 4,5

275* 120 x 80 x 14

278 80 x 80 x 4,5 R55

279* 80 x 80 x 14 R55

280 90 x 90 x 4,5 R55

281* 90 x 90 x 14 R55

284 100 x 100 x 4,5 R55

285* 100 x 100 x 14 R55

288 120 x 120 x 4,5 R55

289* 120 x 120 x 14 R55

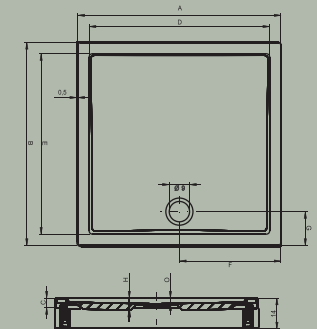
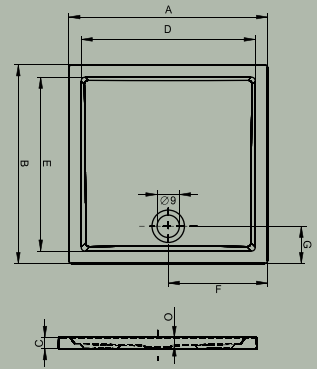
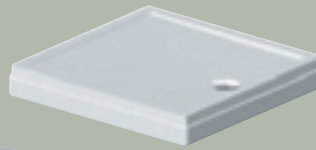

model	code	model	code	A (cm)	B (cm)	C (cm)	D (cm)	E (cm)	F (cm)	G (cm)	O (cm)
248	DA56	249*	DA57	80	80	4,5	70	70	40	15	2,5
250	DA58	251*	DA59	90	90	4,5	80	80	45	15	2,5
252	DA60	253*	DA61	100	90	4,5	90	80	50	15	2,5
254	DA62	255*	DA63	120	90	4,5	110	80	60	15	2,5
256	DA64	257*	DA65	140	90	4,5	130	80	70	15	2,5
258	DA66	259*	DA67	160	90	4,5	150	80	80	15	2,5
260	DA68	261*	DA69	100	100	4,5	90	90	50	15	2,5
270	DA70	271*	DA71	90	80	4,5	80	70	45	15	2,5
272	DA72	273*	DA73	100	80	4,5	90	70	50	15	2,5
274	DA74	275*	DA75	120	80	4,5	110	70	60	15	2,5
276	DA84			180	90	5	170	80	90	15	2,5

* s nohami a panelem
Celková výška 14 cm

*incl. legsand cover panel
Total height 14 cm

* с ножками и панелью
Высота 14 см

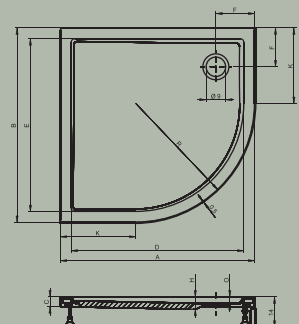
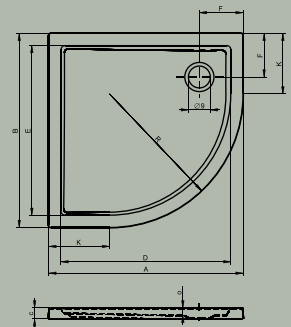

model	code	model	code	A (cm)	B (cm)	C (cm)	D (cm)	E (cm)	F (cm)	K (cm)	O (cm)	R (cm)
278	DA86	279*	DA87	80	80	4,5	70	70	18	25	3	55
280	DA88	281*	DA89	90	90	4,5	80	80	18	35	3	55
284	DA92	285*	DA93	100	100	4,5	90	90	18	45	3	55
288	DA96	289*	DA97	120	120	4,5	110	110	22	65	3	55

* s nohami a panelem
Celková výška 14 cm

*incl. legsand cover panel
Total height 14 cm

* с ножками и панелью
Высота 14 см

AKRYL/ACRYL/АКРИЛ



207 90 x 90 x 8,5

210* 90 x 90 x 8,5

model	code	A (cm)	B (cm)	C (cm)	D (cm)	E (cm)	F (cm)	H (cm)	K (cm)	O (cm)	R (cm)
207	DA21	90	90	3,5	74	74	18,5	11	35	8,5	55
210*	DA19	90	90	3,5	74	74	18,5	11	35	8,5	55

* s nohami a panelem / incl. legs and cover panel/с ножками и панелью

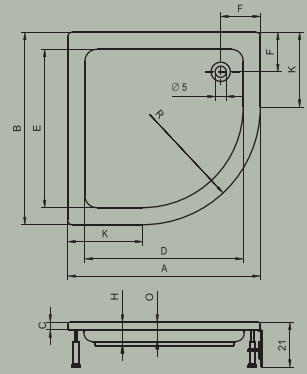

213 90 x 90 x 5

215 100 x 100 x 5

model	code	A (cm)	B (cm)	C (cm)	D (cm)	E (cm)	F (cm)	H (cm)	K (cm)	M (cm)	O (cm)
213	DA23	90	90	3,5	79,5	79,5	20	7,5	39,5	70,5	5
215	DA26	100	100	3,5	89,5	89,5	19,5	7,5	50	70	5

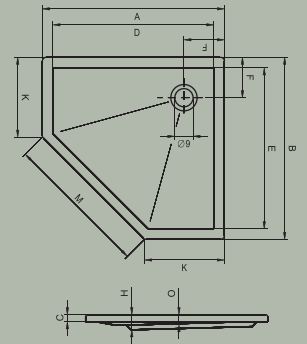

APOLLO 80 x 80 x 13

SATURNUS 90 x 90 x 15,5

model	code	A (cm)	B (cm)	C (cm)	D (cm)	E (cm)	F (cm)	H (cm)	O (cm)
APOLLO	DC01	80	80	3,5	68	68	14	15	13
SATURNUS	DC04	90	90	3,5	77	77	15,5	18	15,5

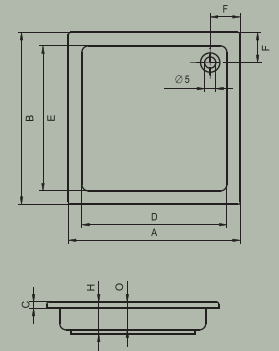

342 90 x 90 x 35

343* 90 x 90 x 35

model	code	A (cm)	B (cm)	C (cm)	D (cm)	E (cm)	F (cm)	H (cm)	K (cm)	M (cm)	O (cm)	R (cm)
342	DB42	90	90	3,5	77	77	59	38	35	32	35	55
343*	DB43	90	90	3,5	77	77	59	38	35	32	35	55

* s nohami a panelem / incl. legs and cover panel/с ножками и панелью

Za příplatek mechanická výpust s přepadem/Mechanical overflow filling for extra charge/доплата – водоспуск

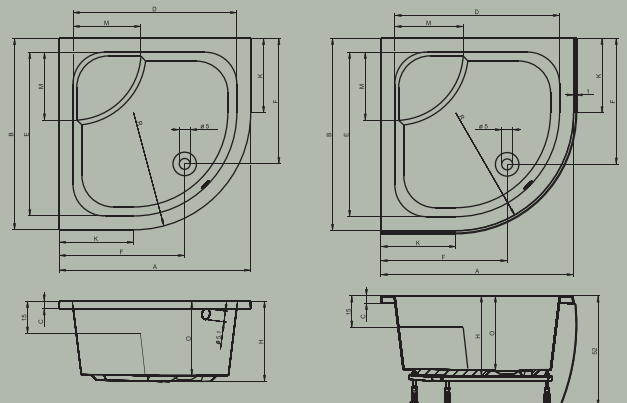

NEREZOVÉ PODLAHOVÉ ŽLABY ŘADY C

THE STAINLESS STEEL SHOWER DRAINS C

ДУШЕВЫЕ ТРАПЫ ИЗ НЕРЖАВЕЮЩЕЙ СТАЛИ СЕРИИ C

Nerezové podlahové žlaby řady C jsou charakterizovány moderním designem a dokonalou funkcí. Základem je nerez ocel o vysoké kvalitě, která se používá pro výrobu samotného sprchového žlabu, vpustí a roštu dle evropských norem. Povrchová úprava nerezových roštů je prováděna kartáčováním do hedvábného lesku. Vnější část zápchového uzávěru je vyrobena z nerez oceli a vnitřní část je vyrobena z polypropylenu.

The Shower Drain C series is characterized by modern design and perfect functionality. The basic is the high quality stainless steel which is used for the production of the shower channel itself, according to the European standards, gully and grating. The foul air trap is made out of polypropylene.

Душевые трапы серии C – характеризуются современным дизайном и наилучшей функциональностью. Основа – высококачественная нержавеющая сталь, которая используется для производства душа. Его канал, согласно европейским стандартам состоит из желоба и решетки.

Затвор неприятного запаха изготовлен из полипропилена.



S horizontální přírubou
With horizontal flange
С горизонтальным фланцем



S horizontální a vertikální přírubou
With vertical flange
С вертикальным фланцем



Bez příruby
Without flange
Без фланца

Snadné čištění

Easy cleaning

несложная очистка



Rošty řady C z nerezové oceli mají jedinečný tvar, u kterého je střední část roštu nižší než hrany. To významným způsobem omezuje riziko přetékání vody.

The stainless steel Shower Drain C gratings have a unique shape in which the middle part of the grating is lower than the edges. This reduces the risk of overshooting of water significantly.

Трап из нержавеющей стали серии C имеет уникальную форму, благодаря которой трение в средней части ниже, чем по краям, это значительно сокращает риск утечки воды.



- průtok/flow/протекающее количество/0,95l/s

- průtok u vstupu sprchy/flow at entrance to enclosure/протекающее количество входа в душу/0,5l/s

- průtok proti stěně/flow against wall/протекающее количество у стены души/0,8l/s

Žlaby s horizontální přírubou

Shower Drains with horizontal flange

Душевые трапы с горизонтальным фланцем

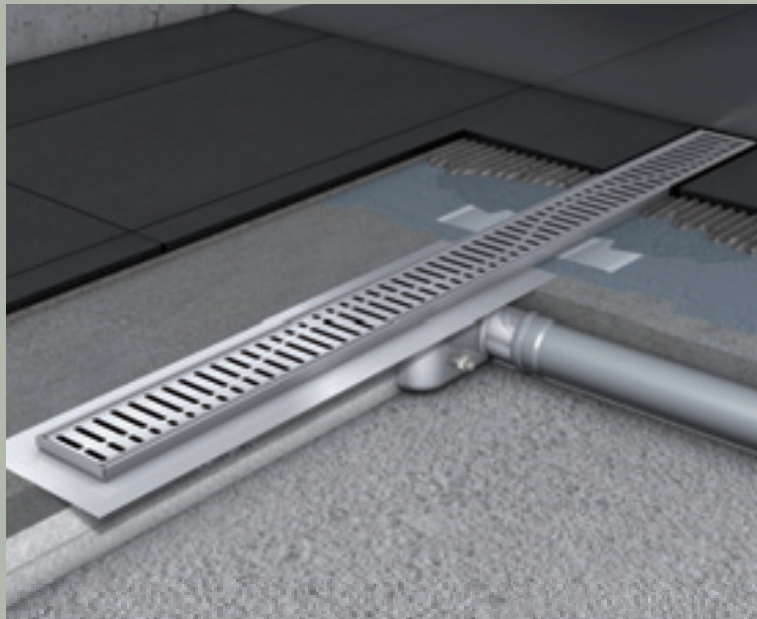

Instalační výška

H - 92 mm se standardním zápachovým uzávěrem (výška vodního sloupce 50 mm)

H - 92 mm with standard FAT (odour seal height 50mm)

H - 92 мм со стандартной толщиной (высота затвора запаха 50 мм)

H - 65 mm se standardním zápachovým uzávěrem (výška vodního sloupce 30 mm)

H - 65 mm with lower FAT (odour seal height 30mm)

H - 65 мм с меньшей толщиной (высота затвора запаха 30 мм)

L1 - délka žlabu bez příruby/length of the drain without flange/длина трапа без фланца

L2 - délka žlabu s přírubou/length of the drain with flange/длина трапа с фланцем

Objednací čísla nerezových žlabů řady C s horizontální přírubou (bez roštu)

Order data – Stainless steel drains range C with horizontal flange

Заказные параметры – Трап из нержавеющей стали C с горизонтальным выпуском

L ₁	L ₂	50 mm	30 mm
585	645	AD04058511600	AD04058511200
685	745	AD04068511600	AD04068511200
785	845	AD04078511600	AD04078511200
885	945	AD04088511600	AD04088511200
985	1045	AD04098511600	AD04098511200
1085	1145	AD04108511600	AD04108511200
1185	1245	AD04118511600	AD04118511200

50 mm
výška pachového uzávěru
height of FAT
высота затвора запаха

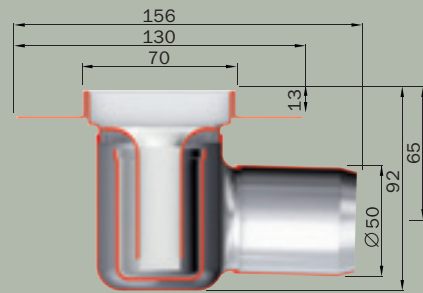

Instalace s horizontální přírubou

Installation with horizontal flange

Инсталляция с горизонтальным фланцем

30 mm
výška pachového uzávěru
height of FAT
высота затвора запаха

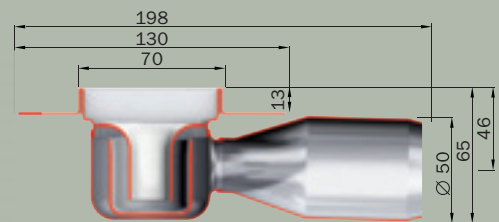

Nízká instalace s horizontální přírubou

Low installation with horizontal flange

Низкая инсталляция с горизонтальным фланцем

Rošty k podlahovým žlabům Gratings/Решетки

ŘADA C

WAVE



SQUARE



WATER



SLOT



TILE



výška dlažby max. 10 mm/height of tile is max. 10 mm/высота плитки макс. 10 мм

SOLID



Objednací čísla roštů (bez žlabů)
Order data – gratings (without drains)
Заказные параметры – решетки (без трапов)



Rošt/Grating/Решетка	L_1			
	585 cm	685 mm	785 mm	885 mm
Wave jednoduchý rošt	AE04058514100	AE04068514100	AE04078514100	AE04088514100
Square jednoduchý rošt	AE04058512100	AE04068512100	AE04078512100	AE04088512100
Water jednoduchý rošt	AE04058516300	AE04068516300	AE04078516300	AE04088516300
Slot jednoduchý rošt	AE04058511100	AE04068511100	AE04078511100	AE04088511100
Tile jednoduchý rošt	AE04058513300	AE04068513300	AE04078513300	AE04088513300
Solid	AE04058516100	AE04068516100	AE04078516100	AE04088516100

Rošt/Grating/Решетка	L_1		
	985 mm	1085 mm	1185 mm
Wave jednoduchý rošt	AE04098514100	AE04108514100	AE04118514100
Square jednoduchý rošt	AE04098512100	AE04108512100	AE04118512100
Water jednoduchý rošt	AE04098516300	AE04108516300	AE04118516300
Slot jednoduchý rošt	AE04098511100	AE04108511100	AE04118511100
Tile jednoduchý rošt	AE04098513300	AE04108513300	AE04118513300
Solid	AE04098516100	AE04108516100	AE04118516100

Žlaby s horizontální a vertikální přírubou
Drains with horizontal and vertical flange
Трапы с горизонтальным и вертикальным фланцем

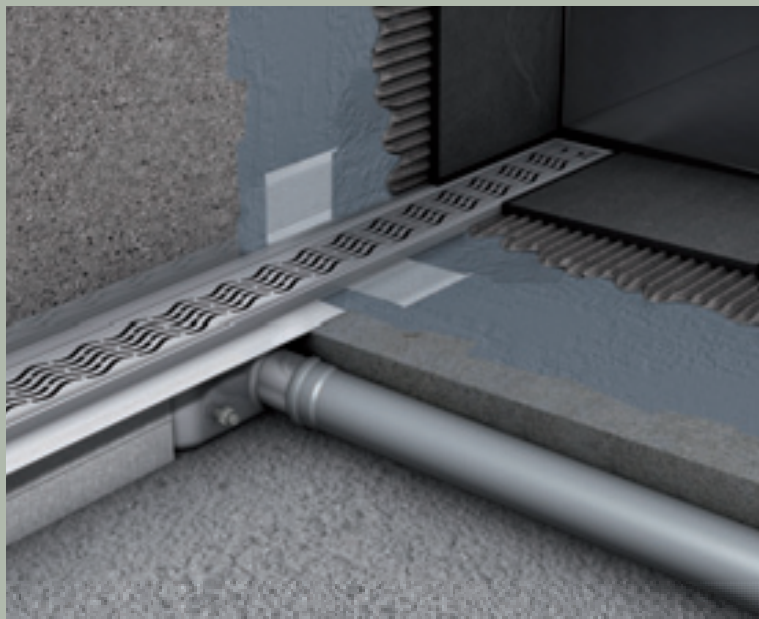

50 mm
výška pachového uzávěru
height of FAT
высота затвора запаха

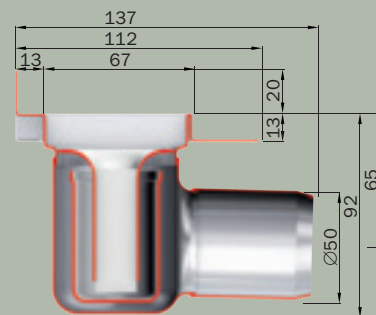

Instalace s horizontální a vertikální přírubou
Installation with horizontal and vertical flange
Инсталляция с горизонтальным и вертикальным фланцем

30 mm
výška pachového uzávěru
height of FAT
высота затвора запаха

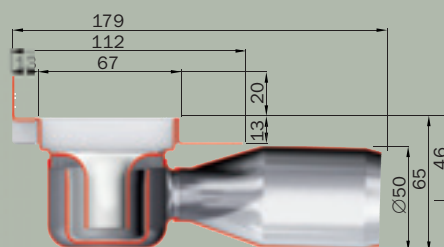

Nízká instalace s horizontální a vertikální přírubou
Low installation with horizontal and vertical flange
Низкая инсталляция с горизонтальным и вертикальным фланцем

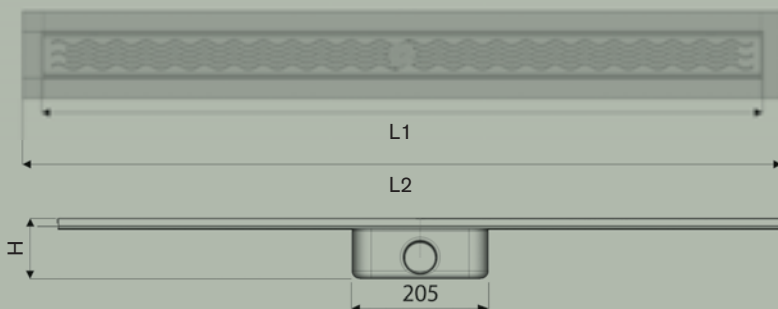

Instalační výška

H - 92 mm se standardním zápachovým uzávěrem (výška vodního sloupce 50 mm)

H - 92 mm with standard FAT (odour seal height 50mm)

H - 92 мм со стандартной толщиной (высота затвора запаха 50 мм)

H - 65 mm se standardním zápachovým uzávěrem (výška vodního sloupce 30 mm)

H - 65 mm with lower FAT (odour seal height 30mm)

H - 65 мм с меньшей толщиной (высота затвора запаха 30 мм)

L1 - délka žlabu bez příruby/length of the drain without flange/длина трапа без фланца

L2 - délka žlabu s přírubou/length of the drain with flange/длина трапа с фланцем

Objednací čísla nerezových žlabů řady C s horizontální a vertikální přírubou (bez roštu)

Order data stainless steel drain range C with horizontal and vertical flange (without grating)

Заказные параметры душевых трапов с горизонтальным и вертикальным фланцем (без решетки)

L1	L2	50 mm	30 mm
585	645	AD04058551600	AD04058551200
685	745	AD04068551600	AD04068551200
785	845	AD04078551600	AD04078551200
885	945	AD04088551600	AD04088551200
985	1045	AD04098551600	AD04098551200
1085	1145	AD04108551600	AD04108551200
1185	1245	AD04118551600	AD04118551200

Rošty k podlahovým žlabům Gratings/Решетки

ŘADA C

WAVE



SQUARE



WATER



SLOT



TILE



výška dlažby max. 10 mm/height of tile is max. 10 mm/высота плитки макс. 10 мм

SOLID



Objednací čísla roštů (bez žlabů)
Order data – gratings (without drains)
Заказные параметры – решетки (без трапов)



Rošt/Grating/Решетка	L_1 585 mm	685 mm	785 mm	885 mm
Wave jednoduchý rošt	AE04058514100	AE04068514100	AE04078514100	AE04088514100
Square jednoduchý rošt	AE04058512100	AE04068512100	AE04078512100	AE04088512100
Water jednoduchý rošt	AE04058516300	AE04068516300	AE04078516300	AE04088516300
Slot jednoduchý rošt	AE04058511100	AE04068511100	AE04078511100	AE04088511100
Tile jednoduchý rošt	AE04058513300	AE04068513300	AE04078513300	AE04088513300
Solid	AE04058516100	AE04068516100	AE04078516100	AE04088516100

Rošt/Grating/Решетка	L_1 985 mm	1085 mm	1185 mm
Wave jednoduchý rošt	AE04098514100	AE04108514100	AE04118514100
Square jednoduchý rošt	AE04098512100	AE04108512100	AE04118512100
Water jednoduchý rošt	AE04098516300	AE04108516300	AE04118516300
Slot jednoduchý rošt	AE04098511100	AE04108511100	AE04118511100
Tile jednoduchý rošt	AE04098513300	AE04108513300	AE04118513300
Solid	AE04098516100	AE04108516100	AE04118516100

Žlaby bez příruby
Drains without flange
Трапы без фланца

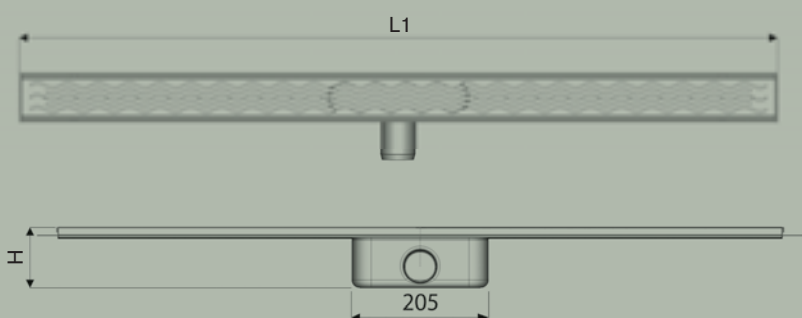
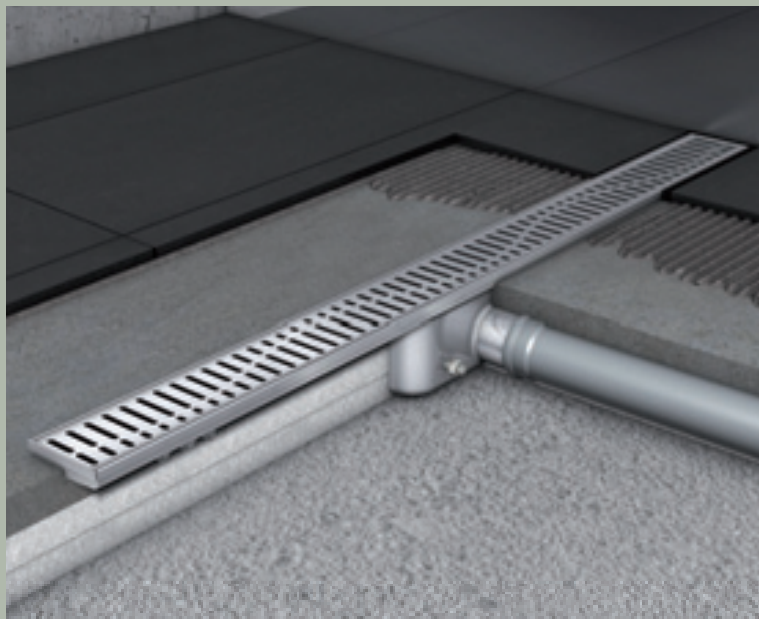

50 mm
výška pachového uzávěru
height of FAT
высота затвора запаха

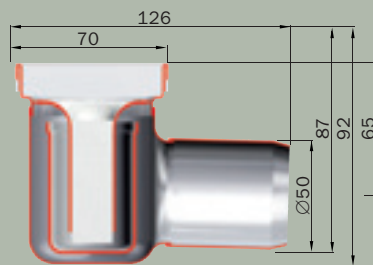

Instalace žlabu bez příruby
Installation of the drain without flange
Инсталация трапа без фланца

30 mm
výška pachového uzávěru
height of FAT
высота затвора запаха

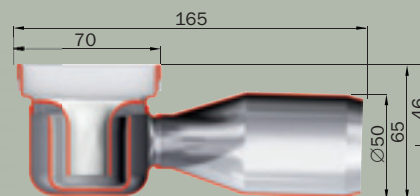

Nízká instalace s vertikální přírubou
Low installation with vertical flange
Низкая инсталация трапа без фланца

Instalační výška

H - 92 mm se standardním zápachovým uzávěrem (výška vodního sloupce 50 mm)

H - 92 mm with standard FAT (odour seal height 50mm)

H - 92 мм со стандартной толщиной (высота затвора запаха 50 мм)

H - 65 mm se standardním zápachovým uzávěrem (výška vodního sloupce 30 mm)

H - 65 mm with lower FAT (odour seal height 30mm)

H - 65 мм с меньшей толщиной (высота затвора запаха 30 мм)

L1 - délka žlabu bez příruby/lenght of the drain without flange/длина трапа без фланца

Objednací čísla nerezových žlabů řady C bez příruby (bez roštu)

Order data – Stainless steel drains range C (without gratings)

Заказные параметры душевых трапов C (без решетки)

L1	50 mm	30 mm
585	AD04058501600	AD04058501200
685	AD04068501600	AD04068501200
785	AD04078501600	AD04078501200
885	AD04088501600	AD04088501200
985	AD04098501600	AD04098501200
1085	AD04108501600	AD04108501200
1185	AD04118501600	AD04118501200

Rošty k podlahovým žlabům Gratings/Решетки

ŘADA C

WAVE



SQUARE



WATER



SLOT



TILE



výška dlažby max. 10 mm/height of tile is max. 10 mm/высота плитки макс. 10 мм

SOLID

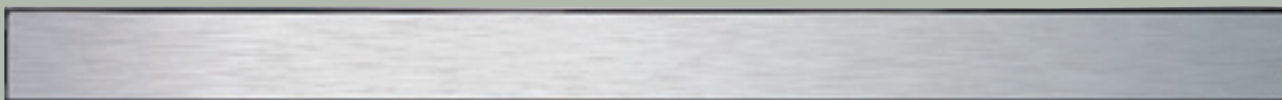

Objednací čísla roštů (bez žlabů)
Order data – gratings (without drains)
Заказные параметры – решетки (без трапов)



Rošt/Grating/Решетка	L_1 585 mm	685 mm	785 mm	885 mm
Wave jednoduchý rošt	AE04058514100	AE04068514100	AE04078514100	AE04088514100
Square jednoduchý rošt	AE04058512100	AE04068512100	AE04078512100	AE04088512100
Water jednoduchý rošt	AE04058516300	AE04068516300	AE04078516300	AE04088516300
Slot jednoduchý rošt	AE04058511100	AE04068511100	AE04078511100	AE04088511100
Tile jednoduchý rošt	AE04058513300	AE04068513300	AE04078513300	AE04088513300
Solid	AE04058516100	AE04068516100	AE04078516100	AE04088516100

Rošt/Grating/Решетка	L_1 985 mm	1085 mm	1185 mm
Wave jednoduchý rošt	AE04098514100	AE04108514100	AE04118514100
Square jednoduchý rošt	AE04098512100	AE04108512100	AE04118512100
Water jednoduchý rošt	AE04098516300	AE04108516300	AE04118516300
Slot jednoduchý rošt	AE04098511100	AE04108511100	AE04118511100
Tile jednoduchý rošt	AE04098513300	AE04108513300	AE04118513300
Solid	AE04098516100	AE04108516100	AE04118516100

NEREZOVÉ PODLAHOVÉ ŽLABY ŘADY E THE STAINLESS STEEL SHOWER DRAINS E ДУШЕВЫЕ ТРАПЫ ИЗ НЕРЖАВЕЮЩЕЙ СТАЛИ СЕРИИ E

Řešení žlabů E jsou řešení, která inspirují kreativní plánování koupelen. Tato řešení však mohou být především přizpůsobena na každý požadovaný design.

Shower drain solutions inspire a creative bathroom planning. Above all, however, they can be adapted to every desired design.

Решение трапов типа E вдохновляют творчески планировать ванную. Эти решения однако могут быть прежде всего приспособлены к каждому выбору дизайна.



V liniovém odvodnění
Linear Solution
Ровный



S mřížkou
v rohovém odvodnění
Corner solution
Угловый с решеткой



Osvětlení/Lightline/Освещение
Sprchový žlab pro řady E je volitelně k dispozici s osvětlením pro liniová, a rohová odvodnění

The shower drain E is available optionally with illumination for straight and corner designs.

Душевый трап типа E можно выбрать с освещением для ровных и угловых

Kvalita nerezových žlabů

Jednotlivé komponenty žlabů řady E jsou navzájem pevně svařeny. Z tohoto důvodu nemůže dojít k prosáknutí, a to ani v důsledku extrémního namáhání, ani z důvodu opotřebení.

Quality

The components of the shower drains are firmly welded with each other. Therefore, leakages cannot develop, neither by extreme stress nor by wear.

Качество нержавеющей трапов

Отдельные компоненты трапов E прочно сварены между собой. Поэтому не могут треснуть и даже в результате экстремальной нагрузки или из-за износа.

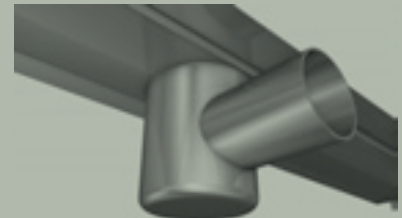

Velké čisticí možnosti

Po odstranění zápachového uzávěru s dvojitým tělesem získáte přístup k celému odpadnímu potrubí. Z tohoto důvodu je pak možno bez problémů vložit do systému čisticí spirálu v případě zanesení potrubí.

Large cleaning section

After removing the dual-body odour seal, the entire pipe section is available. For this reason, a cleaning spiral can be inserted without problems in the case of pipe blockage.

Чистка

После отстранения противозапахового затвора с двойным телом найдёте доступ к сточной трубе. Потом можно вложить в систему очищающую спираль, в случаи загрязнения трубопровода.

- průtok/flow/протекающее количество/0,8l/s
- průtok u vstupu sprchy/flow at entrance to enclosure/протекающее количество входа в душу/0,4l/s
- průtok proti stěně/flow against wall/протекающее количество у стены души/0,6l/s

Nerezové podlahové žlaby

The stainless steel Shower Drains

Душевые трапы из нержавеющей стали

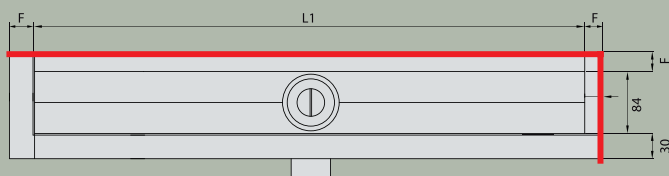
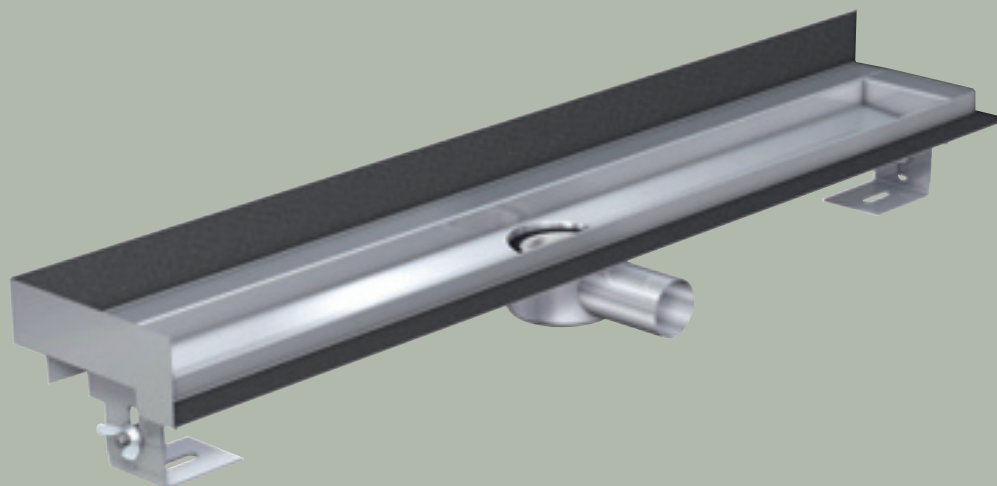

H = 105 až 160 mm s výškou pachového uzávěru 50 mm
 H = 79 až 134 mm s výškou pachového uzávěru 25 mm
 Rozměrové výkresy uvádějí příklady vertikálních přírub na zadní a pravé straně

H = 105 až 160 mm with odou seal height 50 mm
 H = 79 up to 134 mm with odou seal height 25 mm
 The dimensional drawing exemplifies vertical flanges on rear and rightside

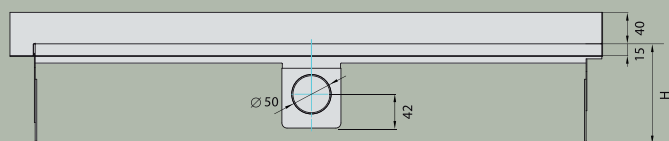

H = 105 до 160 мм с высотой затвора запаха 50 мм
 H = 79 до 134 мм с высотой затвора запаха 25 мм
 На технических рисунках показываются произведения с вертикальным фланцем на задней и правой стороне

Příruba/Flange/фланец	F
Horizontalní/horizontal/горизонтальный	30
Vertikální/vertical/вертикальный	20

Typ vertikální příruby

Type of the vertical flange

Произведение вертикального фланца

L1	č. 50 mm	25 mm
L1	č. 50 mm	25 mm
L1	č. 50 mm	25 mm

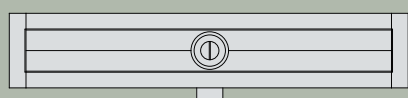

žádná/none/никакой

700	AD01070011600	AD01070011100
800	AD01080011600	AD01080011100
900	AD01090011600	AD01090011100
1000	AD01100011600	AD01100011100
1200	AD01120011600	AD01120011100



zadní/rear/задний

700	AD01070015600	AD01070015100
800	AD01080015600	AD01080015100
900	AD01090015600	AD01090015100
1000	AD01100015600	AD01100015100
1200	AD01120015600	AD01120015100

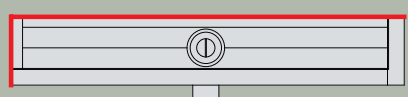

zadní levá/rear and left hand/задний левой

700	AD01070016600	AD01070016100
800	AD01080016600	AD01080016100
900	AD01090016600	AD01090016100
1000	AD01100016600	AD01100016100
1200	AD01120016600	AD01120016100

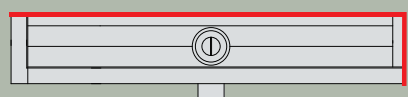









zadní pravá/rear and right hand/задний правой

700	AD01070017600	AD01070017100
800	AD01080017600	AD01080017100
900	AD01090017600	AD01090017100
1000	AD01100017600	AD01100017100
1200	AD01120017600	AD01120017100

Designové rošty z nerez oceli/Design gratings

ŘADA E

from stainless steel/Дизайновые решетки из нержавеющей стали

Design	L1	pro žlaby řady E for drains E для трапов E	pro rohový žlab for corner drain для углового трапа	pro systémové desky for showerboards для системного отвода воды
	398x398	-	AE02039804200	-
	700	AE01070004100	-	AE01070004100
	800	AE01080004100	-	AE01080004100
	900	AE01090004100	-	AE01090004100
	1000	AE01100004100	-	-
	1100	-	-	AE01110004100
	1200	AE01120004100	-	-
	398x398	-	AE02039802200	-
	700	AE01070002100	-	AE01070002100
	800	AE01080002100	-	AE01080002100
	900	AE01090002100	-	AE01090002100
	1000	AE01100002100	-	-
	1100	-	-	AE01110002100
	1200	AE01120002100	-	-
	398x398	-	AE02039801200	-
	700	AE01070001100	-	AE01070001100
	800	AE01080001100	-	AE01080001100
	900	AE01090001100	-	AE01090001100
	1000	AE01100001100	-	-
	1100	-	-	AE01110001100
	1200	AE01120001100	-	-
	398x398	-	AE02039809200	-
	700	AE01070009100	-	AE01070009100
	800	AE01080009100	-	AE01080009100
	900	AE01090009100	-	AE01090009100
	1000	AE01100009100	-	-
	1100	-	-	AE01110009100
	1200	AE01120009100	-	-
	398x398	-	AE02039810200	-
	700	AE01070010100	-	AE01070010100
	800	AE01080010100	-	AE01080010100
	900	AE01090010100	-	AE01090010100
	1000	AE01100010100	-	-
	1100	-	-	AE01110010100
	1200	AE01120010100	-	-
	398x398	-	AE02039811200	-
	700	AE01070011100	-	AE01070011100
	800	AE01080011100	-	AE01080011100
	900	AE01090011100	-	AE01090011100
	1000	AE01100011100	-	-
	1100	-	-	AE01110011100
	1200	AE01120011100	-	-
	398x398	-	AE02039812200	-
	700	AE01070012100	-	AE01070012100
	800	AE01080012100	-	AE01080012100
	900	AE01090012100	-	AE01090012100
	1000	AE01100012100	-	-
	1100	-	-	AE01110012100
	1200	AE01120012100	-	-
	398x398	-	AE02039803200	-
	700	AE01070003100	-	AE01070003100
	800	AE01080003100	-	AE01080003100
	900	AE01090003100	-	AE01090003100
	1000	AE01100003100	-	-
	1100	-	-	AE01110003100
	1200	AE01120003100	-	-
	398x398	-	-	-
	700	AE01070016100	-	-
	800	AE01080016100	-	-
	900	AE01090016100	-	-
	1000	AE01100016100	-	-
	1100	-	-	-
	1200	AE01120016100	-	-

výška dlažby max. 10 mm
height of tile is max. 10 mm
высота плитки макс. 10 мм

Skleněné rošty Glass gratings Стеклянные решетки

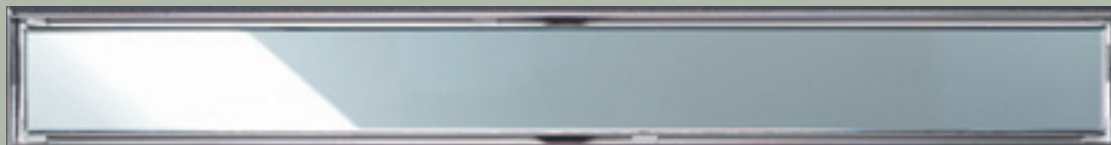

Design

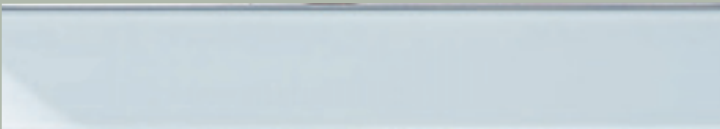
		<i>L1</i>
	sklo, černé	700 AE01070013100
	glass, black	800 AE01080013100
	стекло, чёрное	900 AE01090013100
		1000 AE01100001300
		1200 AE01120001300
	sklo, bílé	700 AE01070014100
	glass, white	800 AE01080014100
	стекло, белое	900 AE01090014100
		1000 AE01100014100
		1200 AE01120014100
	sklo, šedé	700 AE01070015100
	glass, grey	800 AE01080015100
	стекло, серые	900 AE01090015100
		1000 AE01100015100
		1200 AE01120015100



Rohový žlab

The corner shower drain

Угловой трап

Popis výrobku

- sprchový žlab jako rohové odvodnění pro sprchový prostor, vhodné pro všechny systémy nátrubků a hrdel násuvného typu
- instalační výška: 105–160 mm
- standardizované konstrukční parametry odtoku: 0,4 l/s
- šířka žlabu: 84 mm
- délka ramene: 400 mm
- žlab s vnitřním spádem
- odstranitelný zápachový uzávěr tvořený dvěma sifony z nerezové oceli
- sklon: 1,5°
- elektrolyticky leštěný povrch
- příruba pro sítěvkovou izolaci, se stěnovým okrajem u obou předních stran

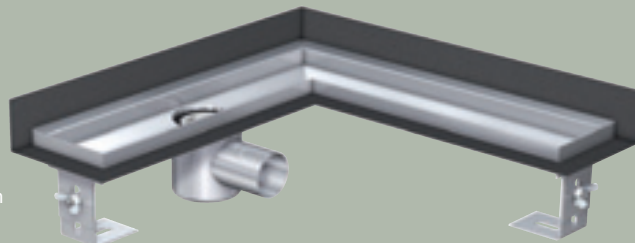

Article description

- drainage channel as corner solution for the shower area, suitable for all push-fit socket systems
- installation height: 105–160 mm
- full stainless steel channel
- standard design outflow capacity: 0,4 l/s
- channel width: 84 mm
- leg length: 400 mm
- drain suitable for all push-fit pipe socket systems
- channel body with lateral slope
- removable dual-body osour seal of stainless steel
- inclination 1,5°
- electro-polished surface
- surrounding, integral thin bed flange with wall lip at both legs

Délka
Lenght
Длина
398x398

obj. č.
art. no.
Код для заказа
AD02039851600

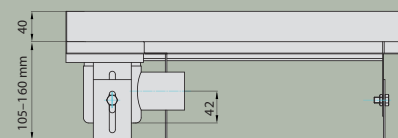

Описание издания

- угловой трап для углового стока из душевого пространства, пригоден для всех систем патрубков
- высота установки: 105–160 мм
- лоток изготовлен из нержавеющей стали
- стандартные параметры конструкции для стока: 0,4 л/сек
- ширина лотка: 84 мм
- длина плеча: 400 мм
- сток DN 50 пригоден для всех систем патрубков и надвигаемых раструбов
- лоток с внутренним уклоном
- съёмный грязеуловитель от запаха, состоящий из двух сифонов из нержавеющей стали
- уклон: 1,5°
- электролитическая полировка поверхности
- уплотнительный фланец для бесшовной изоляции, со сплошным краем с двух передних сторон

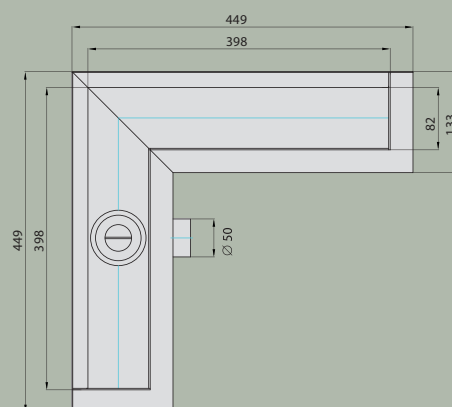

Výhody výrobku

- plně svařované těleso z nerezové oceli, žádné riziko průsaků
- elektrolyticky leštěné tělo pro skvělý vzhled a snadné čištění
- vyrovnávací nohy pro snadnou instalaci
- široký sortiment roštů z nerezové oceli

Product advantages

- full welded stainless steel body, no risk of leakage
- electro-polished body and gratings for great looks and easy cleaning
- levelling feet for easy installation
- wide range of stainless steel gratings

Преимущества издания

- цельносварной блок из нержавеющей стали, полное отсутствие риска просачивания
- электролитическая полировка поверхности для достижения эстетичности вида, простота чистки
- регуляторы высоты для простоты установки
- предусмотрена поставка с освещением
- широкий ассортимент решеток из нержавеющей стали

Osvětlení žlabů

Lightline - illumination for shower drains

Освещение душевых трапов

Popis výrobku

- Osvětlení pro sprchové žlaby řady E
- vhodné pro rošty v provedení nerez ocel, nevhodné pro skleněné a minerální mřížky
- automatické rozsvícení při styku s vodou
- skládá se z těchto prvků: 2 moduly LED s možností opětovného nabití a 1 nízkonapěťová nabíječka
- modul LED je vhodný pro použití pod vodou



Article description

- Illumination kit for E shower channels
- suitable for stainless steel design gratings, not suitable for glass and mineral gratings
- will light automatically when in contact with water
- consisting of: 2 rechargeable LED modules and 1 recharger low voltage
- LED module suitable for underwater use
- available only for ShowerDrain E solutions

Описание изделия

- освещение для душевых трапов серии E
- удобно для решеток из нержавеющей стали, не подходит для стеклянных и минеральных решеток
- автоматическое включение освещения при контакте с водой
- состоит из следующих элементов: 2 LED-модуля с возможностью повторной зарядки и одно зарядное устройство низкого напряжения
- модуль LED пригоден для использования под водой
- предусмотрено только для серии E

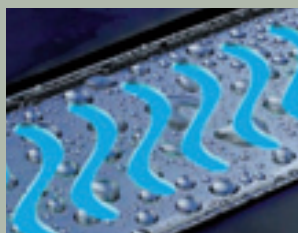

Modrá/Blue/Синий



Červená/Red/Красный



Zelená/Green/Зеленый

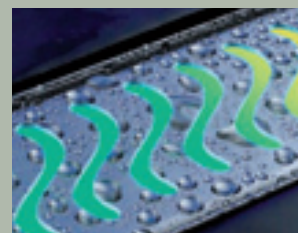

Duhová/Rainbow/Радужный

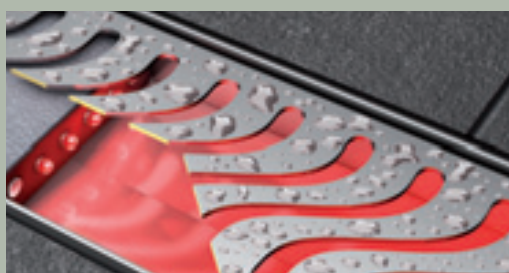

Osvětlení Lightline (2 moduly LED a nabíječka)
Illumination kit (2 LED modules and recharger)

Освещение Lightline (2 LED – модуля и зарядное устройство)

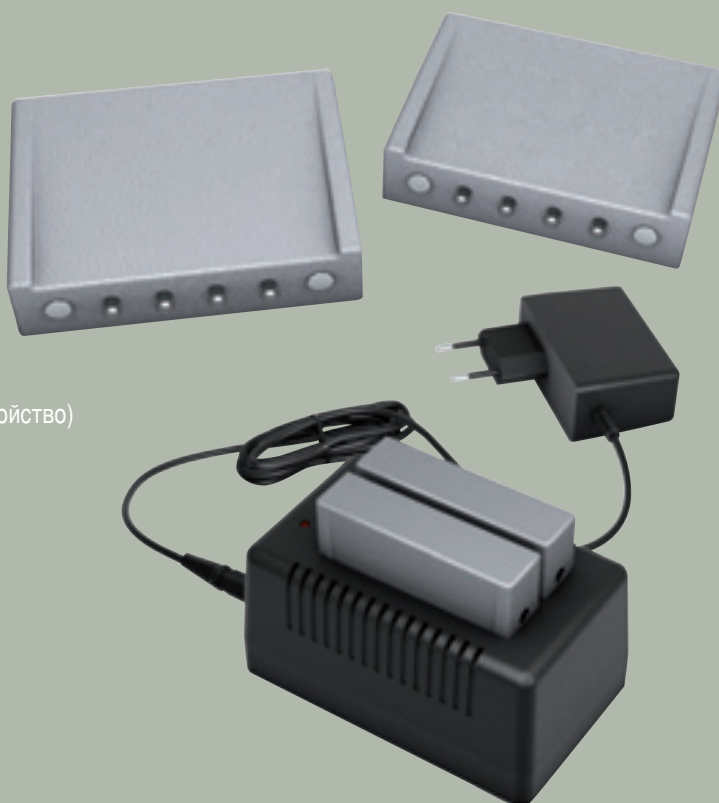

Design	obj. č.
Design	art. no.
Дизайн	Код для заказа
Modrá/Blue	AF01571020501
Červená/Red	AF01571020502
Zelená/Green	AF01571020503
Duhová/Rainbow	AF01571020504

RUG Self - žlab s přírubou

RUG Self - drain with flange

RUG Self - трап с решеткой

ŘADA SELF

Plastová odtoková výpust s pachovým uzávěrem H=87mm
 Plastic drainage outlet with odour seal H=87mm
 Пластиковый отвод с антизапаховым затвором H=87mm

Žlab s roštem z nerezové oceli - jen design Shark
 Shower drain from stainless steel - only design Shark
 Трап с решеткой - нержавеющая сталь

L1	L2	Objednací číslo
683	744	AD06068311640
783	844	AD06078311640
883	944	AD06088311640
983	1044	AD06098311640



Design Shark

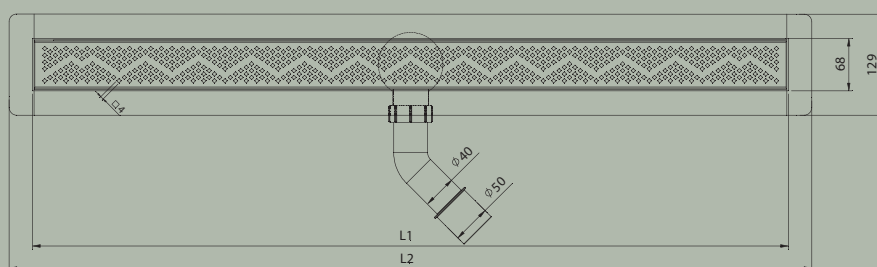

- průtok u vstupu sprchy/flow at entrance to enclosure/протекающее количество входа в душу 0,55l/s
- průtok proti stěně/flow against wall/протекающее количество у стены души 0,35l/s

Nerezový štěrbinový žlab

The stainless slot drain

Нержавеющий щелевой трап

ŘADA SE

Se zadní vertikální přírubou
With rear vertical flange
задний вертикальный фланец



		Instalační výška H	
		105-160 mm	79-134 mm
L1	L2	Objednací číslo	Objednací číslo
700	760	AD05070091600	AD05070091100
800	860	AD05080091600	AD05080091100
900	960	AD05090091600	AD05090091100
1000	1060	AD05100091600	AD05100091100
1200	1260	AD05120091600	AD05120091100

H = 105 až 160 mm s výškou pachového uzávěru 50 mm
H = 79 až 134 mm s výškou pachového uzávěru 25 mm

H = 105 až 160 mm with odour seal height 50 mm
H = 79 up to 134 mm with odour seal height 25 mm

H = 105 до 160 мм с высотой затвора запаха 50 мм
H = 79 до 134 мм с высотой затвора запаха 25 мм

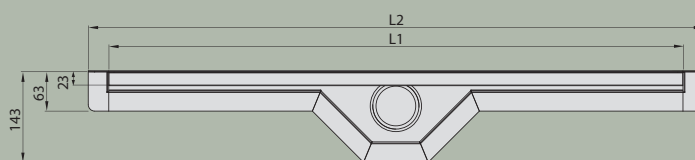
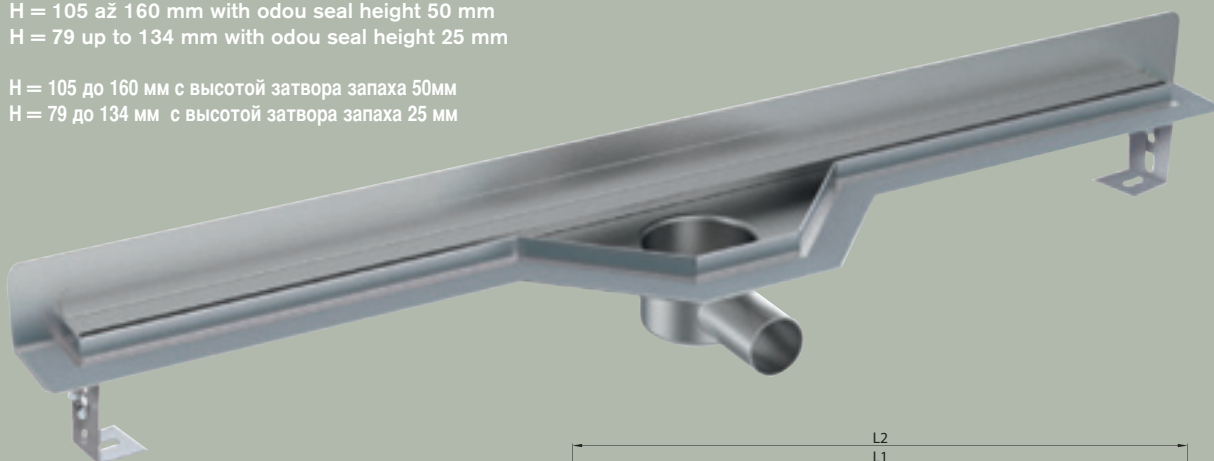

Designový kryt/Design grating/Дизайновые решетки

TILE - pro dlažbu max.10mm/for tile max.10mm/для плиток макс. 10мм



SOLID



šířka (mm)	délka (mm)	Objednací číslo
72	208	TILE AE05020875100
72	208	SOLID AE05020876100

- průtok u vstupu sprchy/flow at entrance to enclosure/протекающее количество входа в душу 0,5l/s
- průtok proti stěně/flow against wall/протекающее количество у стены души 0,3l/s





ПАРНИ́ КАБИНЫ

STEAM CABINS/ПАРОВЫЕ КАБИНЫ

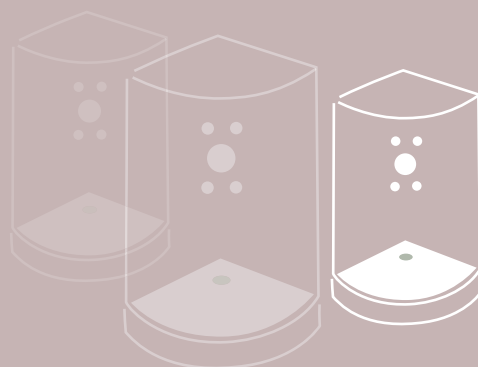



Technický panel mint nebo černý/Technical panel mint or black/Душевая стойка салатная или черная
 * přívod el. energie 400 V, 2-fázové napětí pro generátor páry 5,8 kW
 / must be el. power 400 V and 2 phase voltage for the steam generator 5.8 kW
 /подвод электрической энергии 400 В, двухфазное напряжение для генераторов пара 5,8 кВт

Dveře nejsou součástí parní kabiny/doors are not included in steam cabine/
 двери не включены в паровую кабину

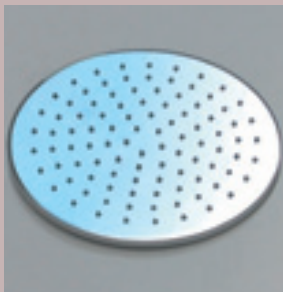

PROF

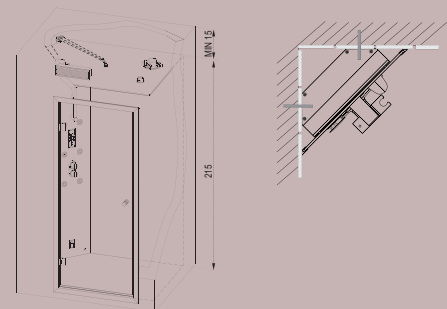
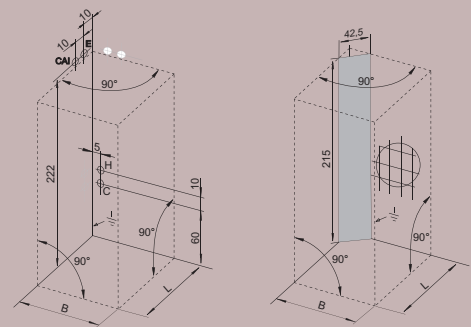
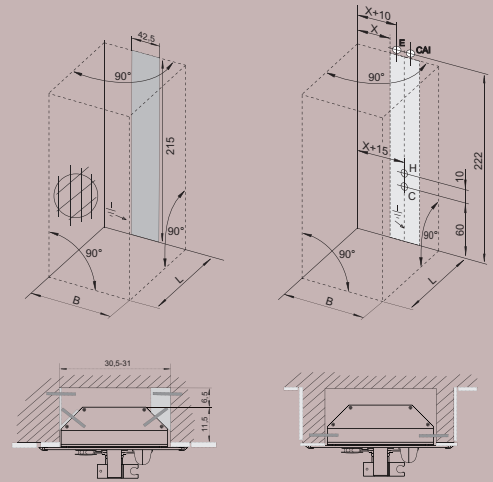

Minimální objem vnitřního prostoru parní kabiny je 1,4m³
 /Minimum inside space of the steam cabine is 1,4m³
 /Минимальное внутреннее пространство паровой кабины – 1,4 м³
 Maximální objem vnitřního prostoru parní kabiny je 4m³
 /Maximum inside space of the steam cabine is 4m³
 /Максимальное внутреннее пространство паровой кабины – 4 м³

C - přívod studené vody / cold water supply / подвод холодной воды
 H - přívod teplé vody / hot water supply / подвод горячей воды
 E - přívod elektrické energie 400V - / power wiring 400V -
 / подвод электричества 400В*
 ⚡ - zemnicí vodič / ground conductor / заземляющий провод
 CAI - externí anténa
 / external antenna
 / внешняя антенна

vybavení za příplatek / option /опция
 rozměry / size / размер 36x35 cm
 nosnost / maximum load / Максимальный вес 130 kg
 Nesmí být použito pro porobetonové zdi/
 it can not be used for aeroconcrete walls/
 Не разрешается использовать для пенобетонных стен

MAJESTIC 90x90 cm 100x90 cm

PROF



MAJESTIC BLACK A

A - výška vaničky/height of shower tray/высота поддона 4,5 cm;
 B - výška vaničky/height of shower tray/высота поддона 14,0 cm
 Technický panel mint nebo černý/Technical panel mint or black/Душевая стойка салатная или черная



MAJESTIC MINT B



vybavení za příplatek / option / опция
 rozměry / size / размер 36x35 cm
 nosnost / maximum load / Максимальный вес 130 kg

Nesmí být použito pro porobetonové zdi/it can not be used for aerobeton walls/
 Не разрешается использовать для пенобетонových стен



PROF

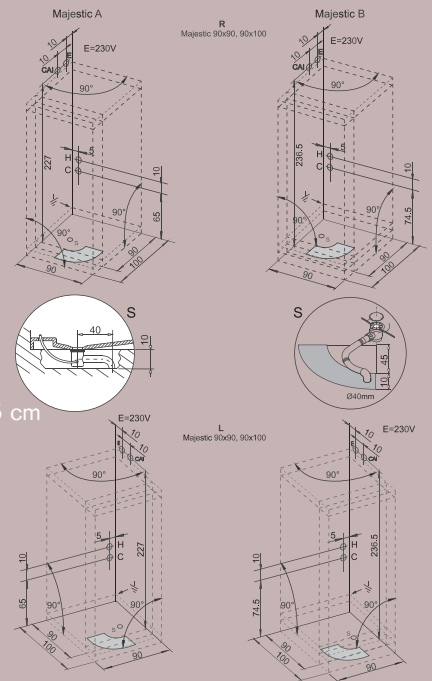
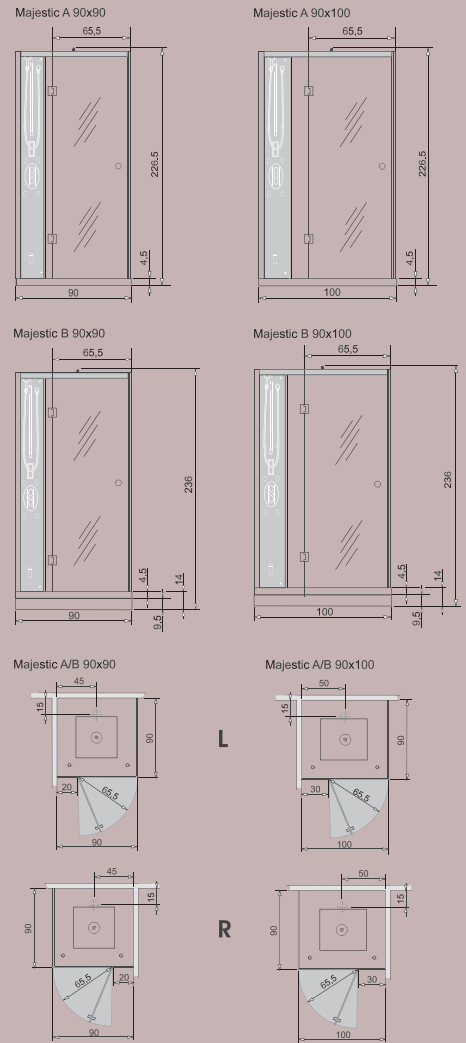

C - přívod studené vody / cold water supply / подвод холодной воды
 H - přívod teplé vody / hot water supply / подвод горячей воды
 E - přívod elektrické energie 230V~ / power wiring 230V~ / подвод электричества 230В
 ⊥ - zemní vodič / ground conductor / заземляющий провод
 CAI - externí anténa / external antenna / внешняя антенна

Парні kabiny/Steam cabins/Ларовые кабины

MAJESTIC *120x90 cm *140x90 cm

PROF

Рамі кабіну/Steam cabins/Паровые кабины



MAJESTIC BLACK B

A - výška vaničky/height of shower tray/высота поддона 4,5 cm;
 B - výška vaničky/height of shower tray/высота поддона 14,0 cm
 Technický panel mint nebo černý/Technical panel mint or black/Душевая стойка салатная или черная
 * přívod el. energie 400 V, 2-fázové napětí pro generátor páry 5,8 kW
 / must be el. power 400 V and 2 phase voltage for the steam generator 5.8 kW
 /подвод электрической энергии 400 В, двухфазное напряжение для генераторов пара 5,8 кВт



vybavení za příplatek / option
 /опция
 rozměry / size / размер 36x35 cm
 nosnost / maximum load /
 Максимальный вес 130 kg
 Nesmí být použito pro
 porobetonové zdi/it can not be
 used for aeroconcrete walls/
 Не разрешается использовать для
 пенобетонových стěn



PROF

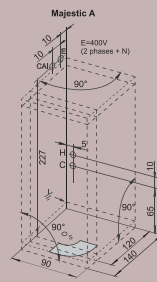
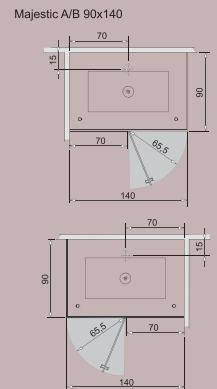
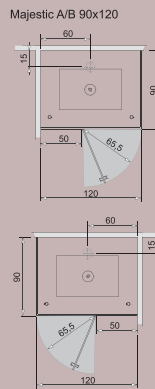
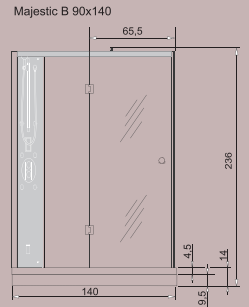
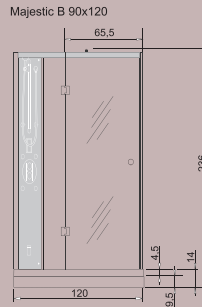
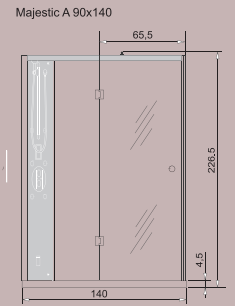
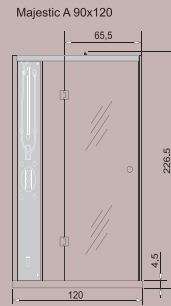

R Majestic 90x120, 90x140

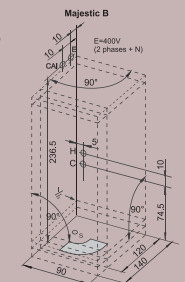

Majestic B

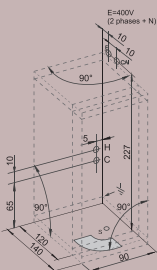
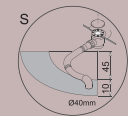
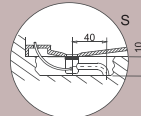

L Majestic 90x120, 90x140

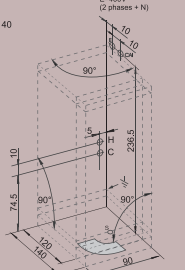

C - přívod studené vody / cold water supply / подвод холодной воды
 H - přívod teplé vody / hot water supply / подвод горячей воды
 E - přívod elektrické energie 400V~ / power wiring 400V~
 / подвод электричества 400В*
 ⊥ - zemnicí vodič / ground conductor / заземляющий провод
 CA1 - externí anténa
 / external antenna
 / внешняя антенна



MEMPHIS A

A - výška vaničky/height of shower tray/высота поддона 5,5 cm;
 B - výška vaničky/height of shower tray/высота поддона 14,5 cm

** sprchová vanička + horní kryt - litý mramor / shower tray + cover - synthetic marble
 / душевой поддон + верхняя крышка - литой мрамор



AS01105

vybavení za příplatek
 / option / опция

rozměry / size / размер 36x29 cm

nosnost / maximum load

/ Максимальный вес 200 kg

Memphis A

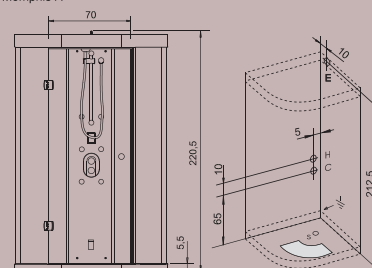

Memphis B

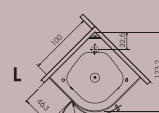
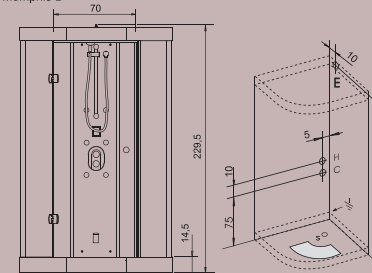

L

R

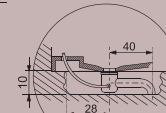

Memphis A

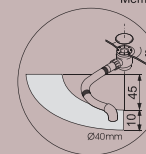

Memphis B

C - přívod studené vody / cold water supply / подвод холодной воды
 H - přívod teplé vody / hot water supply / подвод горячей воды
 E - přívod elektrické energie 230V~ / power wiring 230V~
 / подвод электричества 230В
 ⊕ - zemnicí vodič / ground conductor / заземляющий провод

NEVADA 90x90 cm *100x100 cm *120x120 cm

PROF

Parní kabína/Steam cabins/Паровые кабины



NEVADA B

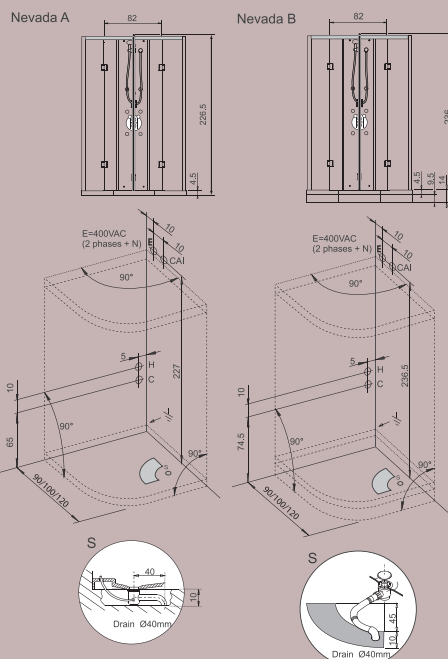

Nevada A/B

90x90

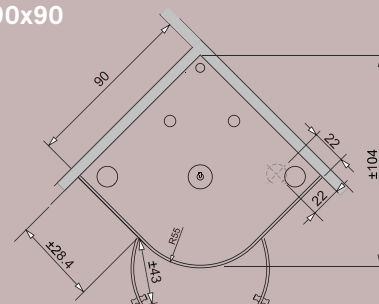

100x100

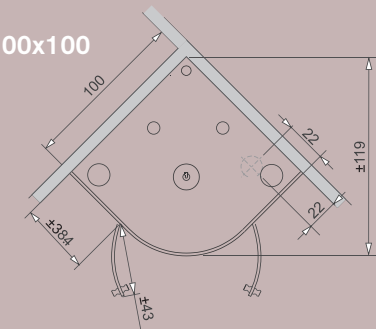

120x120

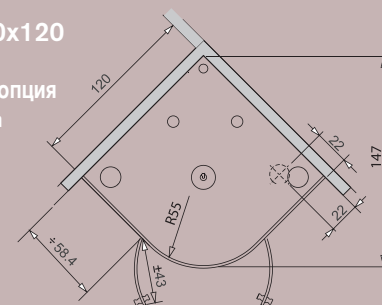

A - výška vaničky/height of shower tray/высота поддона 4,5 cm;
 B - výška vaničky/height of shower tray/высота поддона 14,0 cm
 Technický panel mint nebo černý/Technical panel mint or black/Душевая стойка салатная или черная
 * přívod el. energie 400 V, 2-fázové napětí pro generátor páry 5,8 kW
 / must be el. power 400 V and 2 phase voltage for the steam generator 5.8 kW
 /подвод электрической энергии 400 В, двухфазное напряжение для генераторов пара 5,8 кВт



vybavení za příplatek / option / опция
 rozměry / size / размер 36x35 cm
 nosnost / maximum load /
 Максимальный вес 130 kg

Nesmí být použito pro porobetonové zdi/it can not be used for aroconcrete walls/
 Не разрешается использовать для пенобетонových стен



NEVADA A



PROF

C - přívod studené vody / cold water supply / подвод холодной воды
 H - přívod teplé vody / hot water supply / подвод горячей воды
 E - přívod elektrické energie 230V~ / power wiring 230V~
 / подвод электричества 230В
 ⊕ - zemnicí vodič / ground conductor / заземляющий провод
 CAI - externí anténa / external antenna / внешняя антенна

PRIMO 95x95 cm

EASY/PROF

ČTVRTKRUH/ROUND/КВАДРАНТ



PRIMO ROUND PROF

PRIMO
ČTVRTKRUH
/ROUND
/КВАДРАНТ
R=55 cm

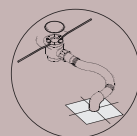
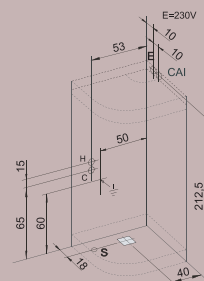
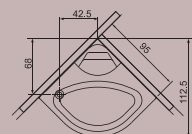
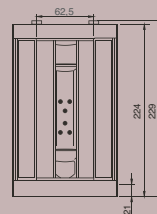

C - přívod studené vody / cold water supply / подвод холодной воды
H - přívod teplé vody / hot water supply / подвод горячей воды
E - přívod elektrické energie 230V~ / power wiring 230V~
/ подвод электричества 230В
⊥ - zemnicí vodič / ground conductor / заземляющий провод
CAI - externí anténa - pouze u provedení PROF
/ external antenna - only PROF version
/ внешняя антенна - только у исполнения PROF



VERONA TECH 2 PROF

VERONA TECH 2

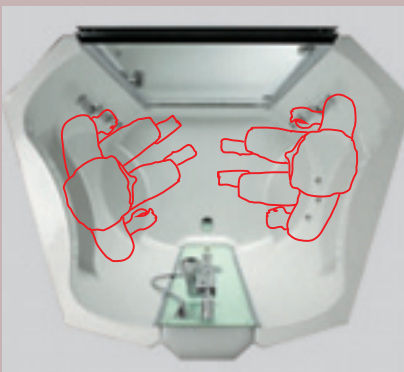
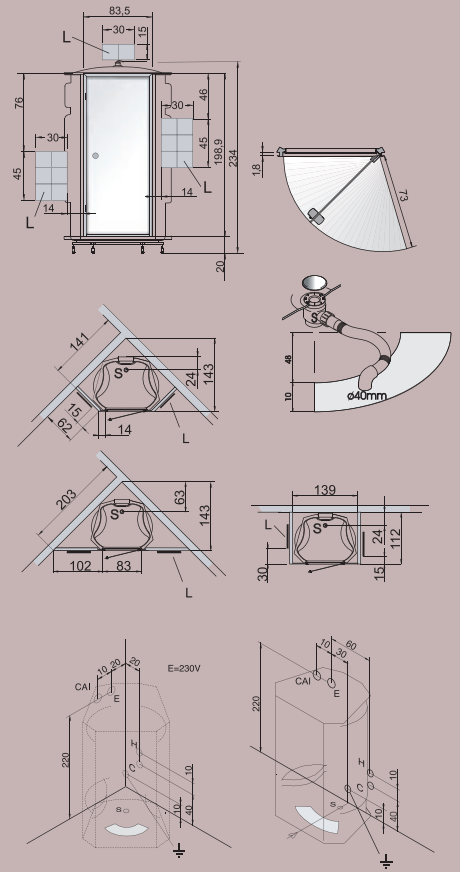

- C - přívod studené vody / cold water supply / подвод холодной воды
- H - přívod teplé vody / hot water supply / подвод горячей воды
- E - přívod elektrické energie 230V~ / power wiring 230V~ / подвод электричества 230В~
- ⊥ - zemní vodič / ground conductor / заземляющий провод
- CAI - externí anténa / external antenna / внешняя антенна
- L - servisní otvory / service opening / сервисные отверстия



PROF

	VERONA PROF	MEMPHIS	NEVADA PROF	MAJESTIC PROF	FLEX PROF	PRIMO EASY	PRIMO PROF
 Osvětlení Light Подсветка	•	• 2X	• 2X	• 2X	• 2X	•	•
 Turecká parní lázeň Turkish bath Турецкая паровая бан	•	•	•	•	•	•	•
 Vertikální hydromasážní trysky Vertical hydro massage jets Вертикальные гидромассажные форсунки	• 6X	• 6X	• 6X	• 6X	• 6X	• 6X	• 6X
 Ruční sprcha Hand shower Ручной душ	•	•	•	•	•	•	•
 Hlavová sprcha Head shower Головной душ	•	•	•	•	•	•	•
 Alarm Alarm Сигнал тревоги	•	•	•	•	•	•	•
 Zádové hydromasážní trysky Back hydro massage jets Бедерные гидромассажные форсунки	• 3X						• 3X
 Bederní hydromasážní trysky Loins hydro massage jets Дерék hydro masszázis fúvókák	• 3X						• 3X
 Funkce kaskáda Waterfall Функция каскад	•						•
 Rádio Radio Радио	•		•	•	•		•
 Změna nastavení Change options Изменение настройки	•		•	•	•		•
 LCD displej LCD display LCD дисплей	•		•	•	•		•
 Termostat.baterie Grohe 2000 Thermostatic mixer Grohe 2000 Термостатический смеситель	•	•	•	•	•	•	•

RIHO kabiny jsou speciálně vyvinuty pro domácí užívání a lze je obdržet v barvách bílá a pergamon.

Pro instalaci parní/sprchovací kabiny RIHO potřebujete: vodovodní přípojku na studenou vodu, odtok s průměrem 40 mm, elektrickou přípojku na 230 V (uzemněnou a se samostatným jištěním), zdroj teplé vody s minimálním tlakem 1 1/2 Bar (doporučujeme 2 a více barů), dodávající min. 8 litrů za minutu s teplotou vody 60°C.

Nevada 100, 120, Majestic 120, 140 a Flex: přívod el. energie 400 V, 2-fázové napětí pro generátor páry 5,8 kW.

Pro sestavení kabiny je zapotřebí pracovní prostor cca 2,5 x plocha kabiny (měřeno od zadní části stěny).

RIHO steam cabins are specially developed for home use and they are available in white and pergamon colours.

To use your RIHO steam/shower cabins, you will need: cold-water distribution pipe, outlet with 40-mm diameter, 230 V electric connection (grounded and with special fuse), sufficient source of heat (combined heater will be the best) with minimum pressure of 1 1/2 bar (we advice 2 bars or more), giving min. 8 litres of 60°C water per minute. The above mentioned requirements are a standard in your housing unit as a rule. Nevada 100, 120, Majestic 120, 140 and Flex: must be el. power 400 V and 2 phase voltage for the steam generator 5.8 kW. The working area of approx. 2.5 x cabin area is needed for cabin assembly (measured from the back wall).

Кабины RIHO разработаны специально для домашнего использования, и изготавливаются в цветах белый и пергамон.

Для подключения Вашей паровой / душевой кабины RIHO необходимо: подключение водопровода с холодной водой, сток с диаметром 40 мм, шина для 230 Вольт (заземленная и со специальным предохранителем), достаточный источник тепла (лучше комбинированный обогреватель) с минимальным давлением 1/2 бар (рекомендуем больше 2 бар), с минимальным расходом 8 литров в минуту 60 °С. Обычно Ваше жилье всем этим обеспечено.

Nevada 100, 120, Majestic 120, 140 и Flex: подвод электрической энергии 400 В, двухфазное напряжение для генераторов пара 5,8 кВт.

Для установки кабины необходимо рабочее пространство прилб. 2,5 x площадь кабины (измерение от задней части стены).





NÁBYTEK

FURNITURE / МЕБЕЛЬ



ANDORA





ANDORA

Nábytek / Furniture / Мебель





ANDORA

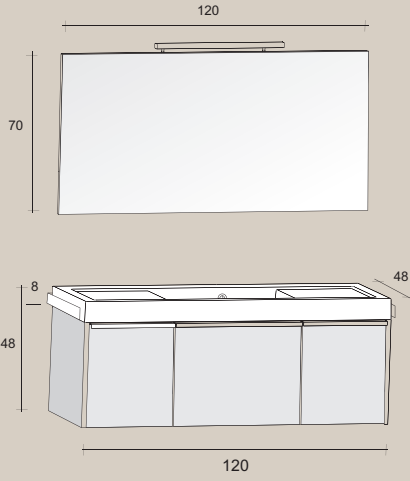

Set 21

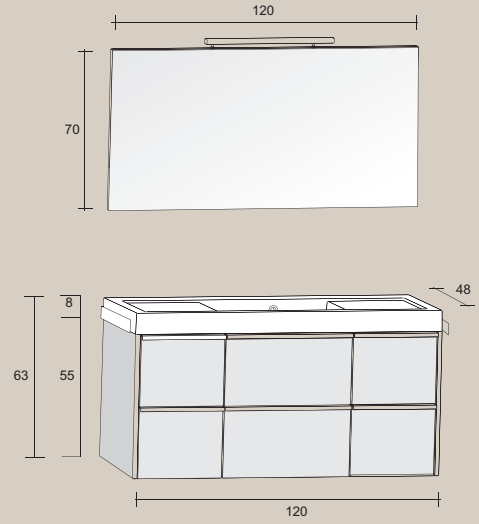

Set 31

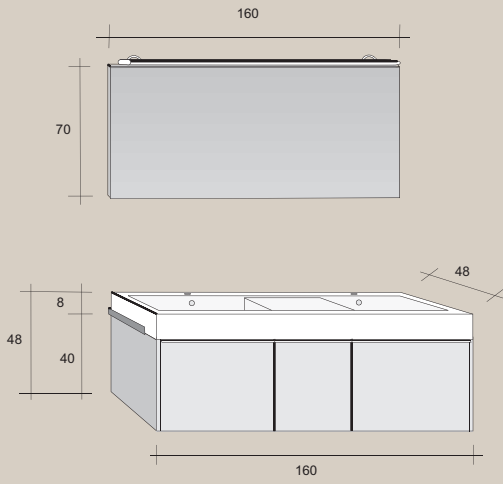

Set 03

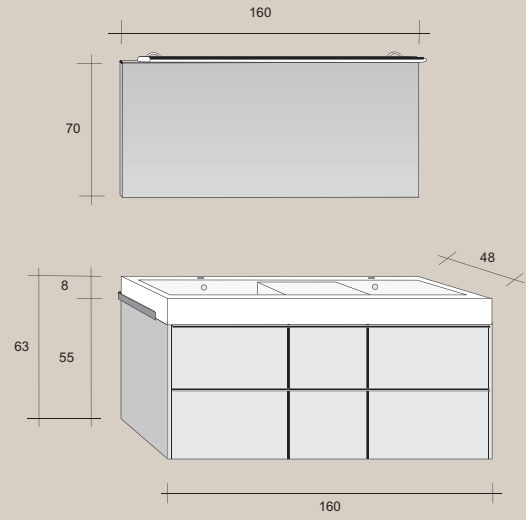

Set 10

Umyvadlo
Wash basin
Раковина

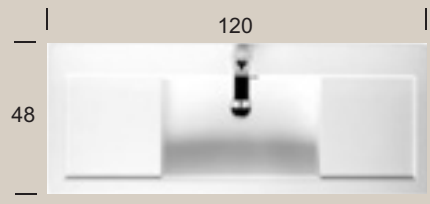

Barevné provedení
Colours
Расцветка

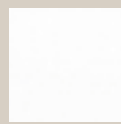

D00

bílá
white
белая

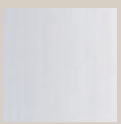

D10

bílá-struktura
white-structure
белая-структура

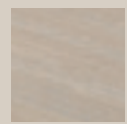

DEC

cremona

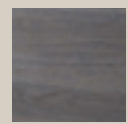

DCA

chateau

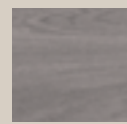

DOR

orne

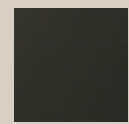



BLK

černá-struktura
black-structure
чёрная-структура

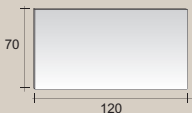
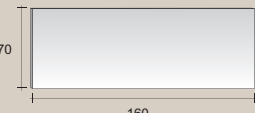
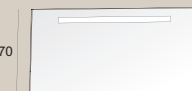
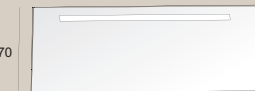
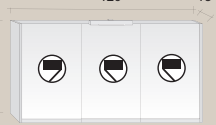
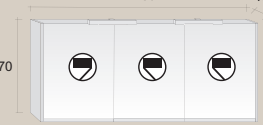
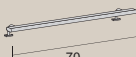
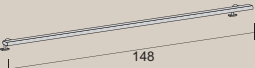
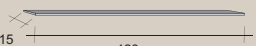
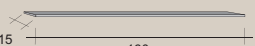
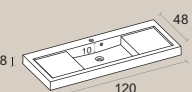
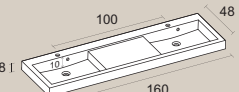
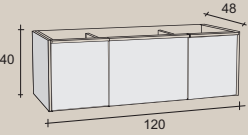
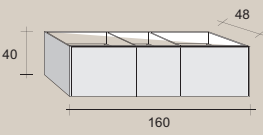
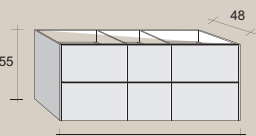
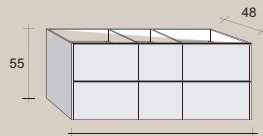
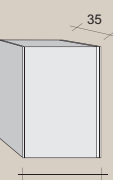
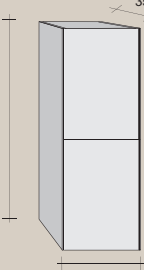
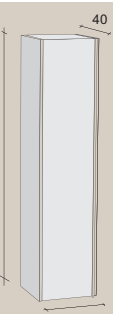
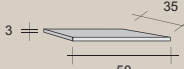
ANDORA

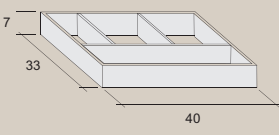
Zrcadlo Mirror Зеркало	120 	160 	
Zrcadlo s osvětlením Mirror with lighting Зеркало со светом	120 	160 	
Zrcadlová skříňka Mirror cabinet Шкафчик с зеркалом	120 13 70 	160 13 70 	
Osvětlení Lighting Освещение	70 	148 	
Police Shelf Полочка	15 120 	15 160 	
Umyvadlo Wash basin Раковина	81 120 48 	81 100 160 48 	
Umyvadlová skříňka Wash basin cabinet Шкафчик под раковину	40 120 48 	40 160 48 	
Umyvadlová skříňka Wash basin cabinet Шкафчик под раковину	55 120 48 	55 160 48 	
Skříňka Cabinet Шкафчик	68,5 35 50 	137,4 35 50 	171,5 40 40 
Krycí deska Cover board Декоративная доска	3 35 50 		

<p>Držák Towel holder Держатель для полотенца</p>		
<p>Organizér zásuvky Drawer organizer Разделение для выдвижного шкафчика</p>		
<p>Výpust (Clac-Clac) Clac Clac Водослив для умывальника</p>		

BOLOGNA





BOLOGNA





BOLOGNA

Umyvadlo
Wash basin
Раковина

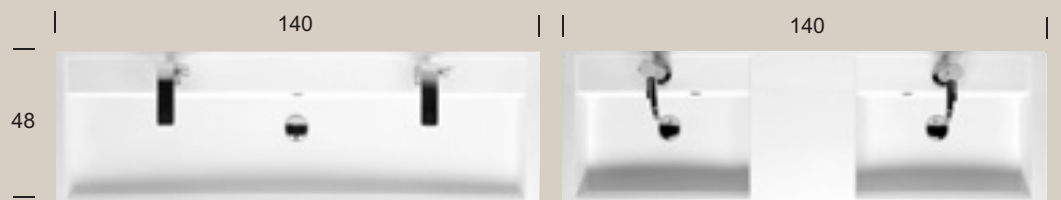
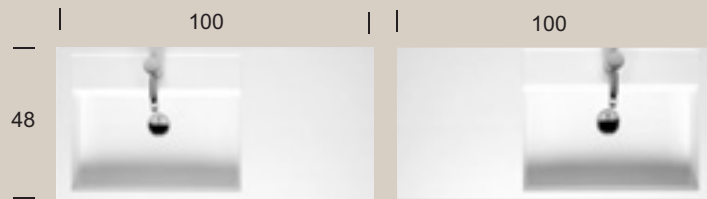
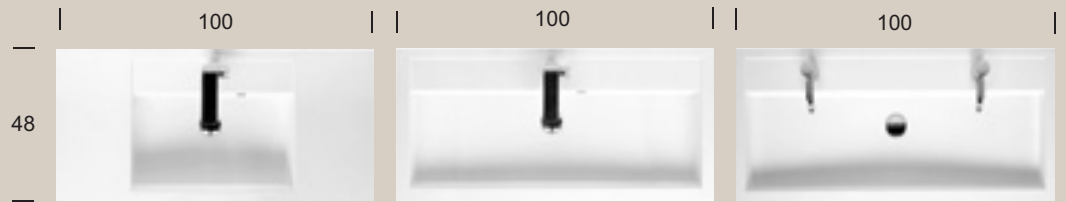
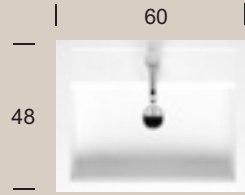

Barevné provedení
Colours
Расцветка

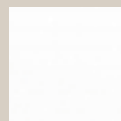

D00

bílá
white
белая



D10

bílá-struktura
white-structure
белая-структура

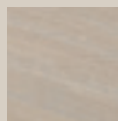

DEC

cremona

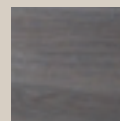

DCA

chateau

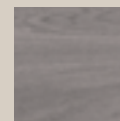

DOR

orme

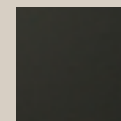

BLK

černá-struktura
black-structure
чёрная-структура

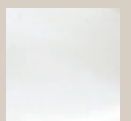

R01

bílá-lesk
white-shiny
белая-лоск

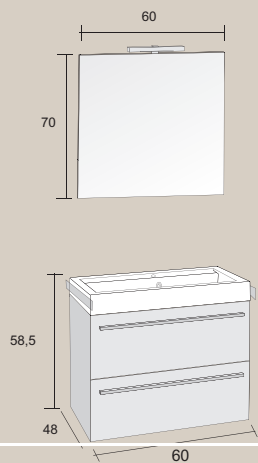

Set 33

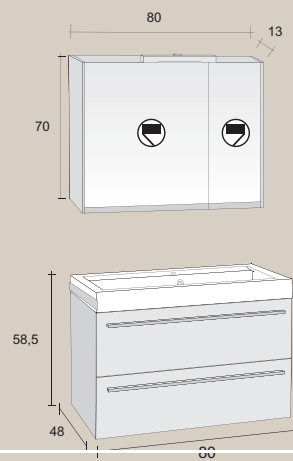

Set 38

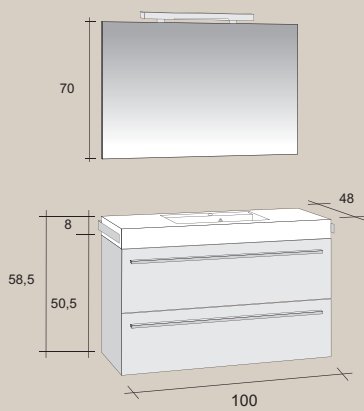

Set 31

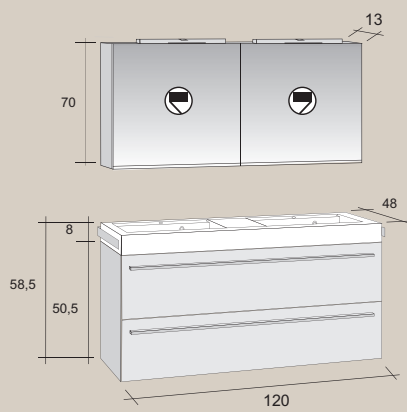

Set 25

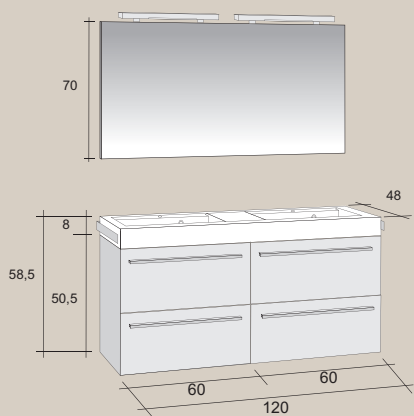

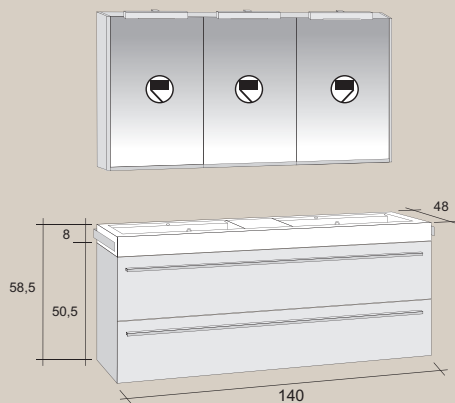

Set 35

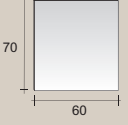
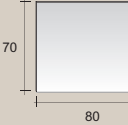
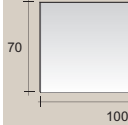
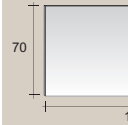
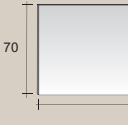
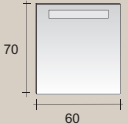
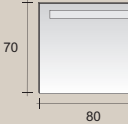
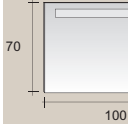
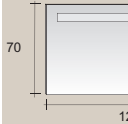
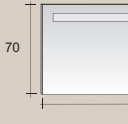
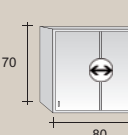
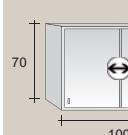
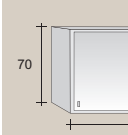
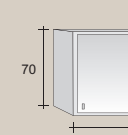
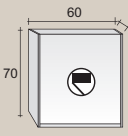
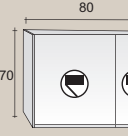
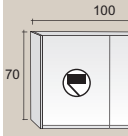
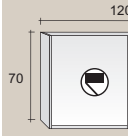
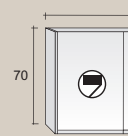
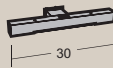

Set 27

BOLOGNA

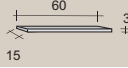
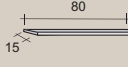
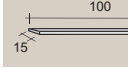
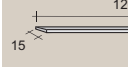
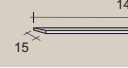
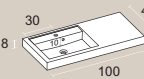
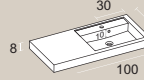
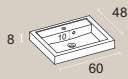
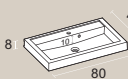
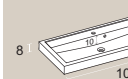
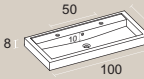
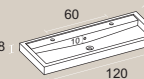
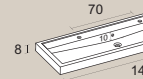
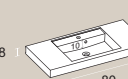
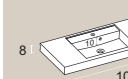
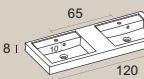
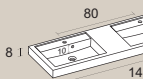
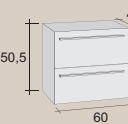
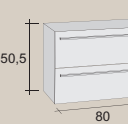
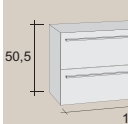
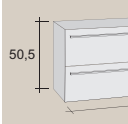
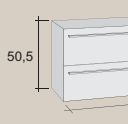
Zrcadlo Mirror Зеркало	60 	80 	100 	120 	140 
Zrcadlo s osvětlením Mirror with lighting Зеркало со светом	60 	80 	100 	120 	140 
Zrcadlová skříňka Mirror cabinet Шкафчик с зеркалом		80 	100 	120 	140 
Zrcadlová skříňka Mirror cabinet Шкафчик с зеркалом	60 	80 	100 	120 	140 
Osvětlení Lighting Освещение					
Police Shelf Полочка	60 	80 	100 	120 	140 
Umyvadlo Wash basin Раковина			30 48 100 		
			30 48 100 		
	8 48 60 	8 48 80 	8 48 100 		
			8 48 100 	8 48 120 	8 48 140 
		8 48 80 	8 48 100 	8 48 120 	8 48 140 
Umyvadlová skříňka Wash basin cabinet Шкафчик под раковину	50,5 60 48 	50,5 80 48 	50,5 100 48 	50,5 120 48 	50,5 140 48 

Skříňka
Cabinet
Шкафчик

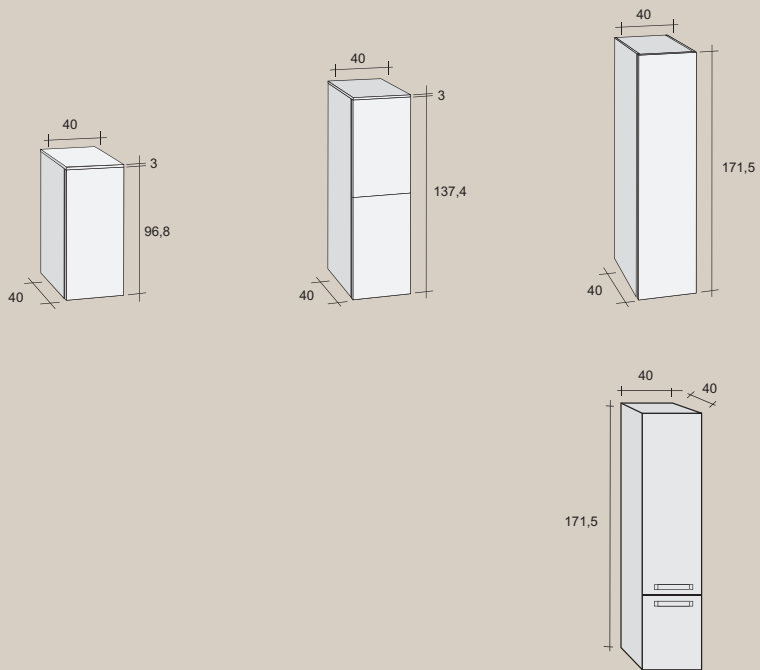

Krycí deska
Cover board
Разделение для выдвижного шкафчика

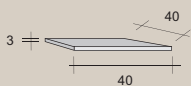

Držák
Towel holder
Держатель для полотенца



Sifon chromový
Chrome siphon
Разделение для выдвижного шкафчика



Organizér zásuvky
Drawer organizer
Разделение для выдвижного шкафчика

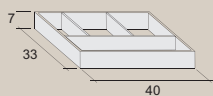

Výpust (Clic-Clac)
Clic Clac
Водослив для умывальника



BRONI



Umyvadlo
Wash basin
Раковина

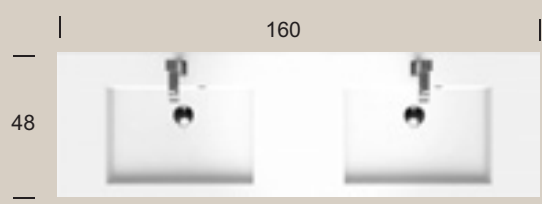
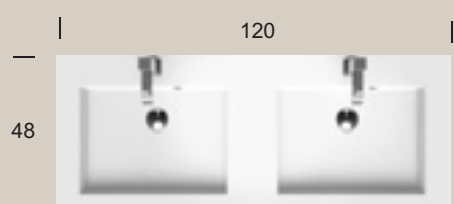
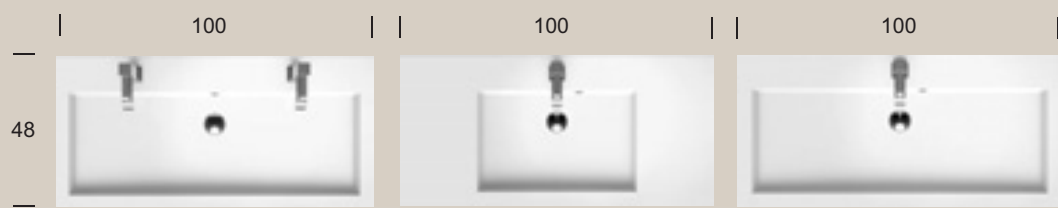
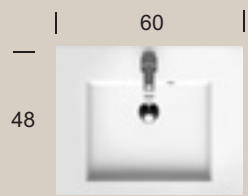

Barevné provedení
Colours
Расцветка



D00	D10	DEC	DCA	DOR	BLK	R01
bílá white белая	bílá-struktura white-structure белая-структура	cremona	chateau	orme	černá-struktura black-structure чёрная-структура	bílá-lesk white-shiny белая-лоск

BRONI

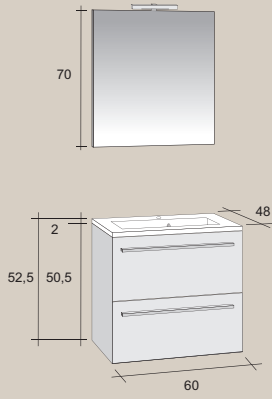

Set 33

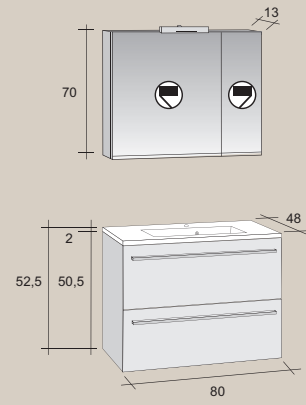

Set 38

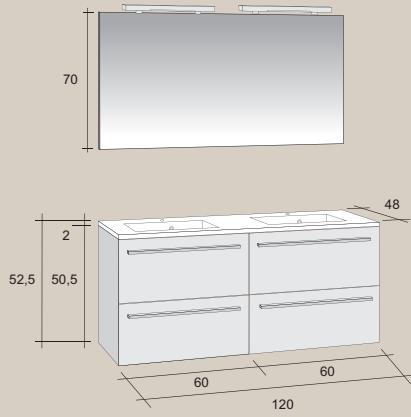

Set 35

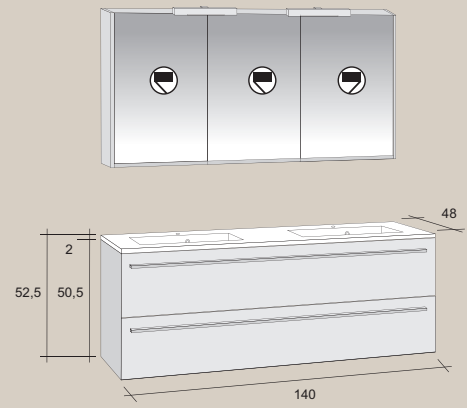

Set 27

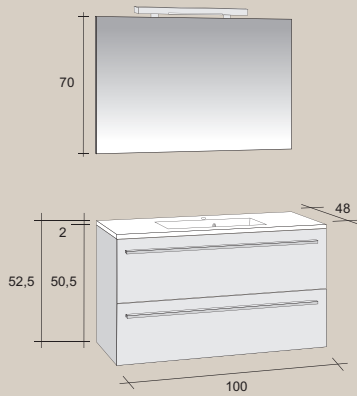



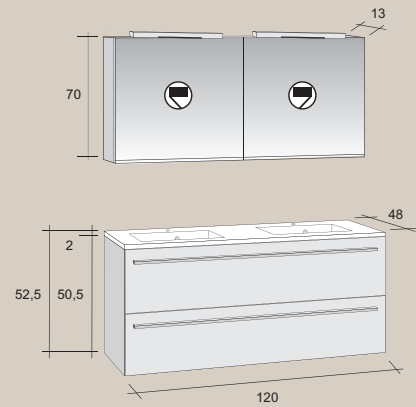







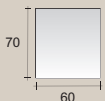

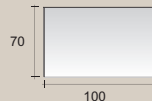

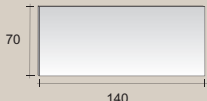
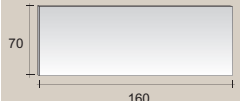
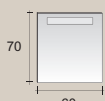

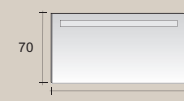
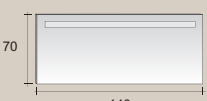
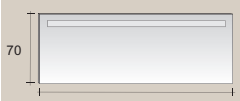
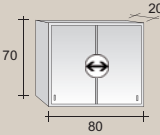
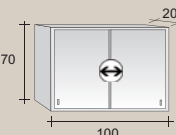
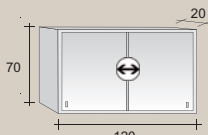
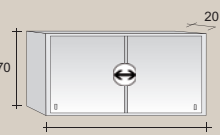
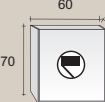
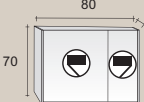
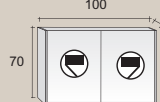
Set 31





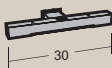
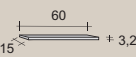
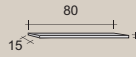
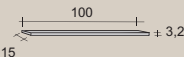
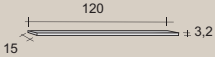

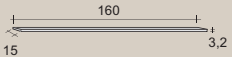
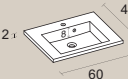
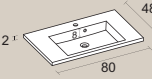
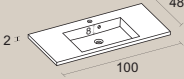
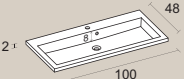
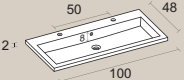
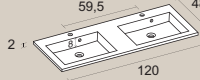
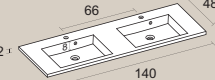
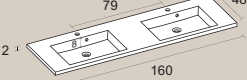
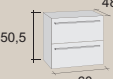
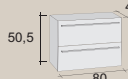
Set 25

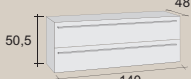
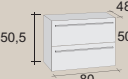
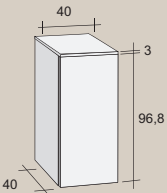
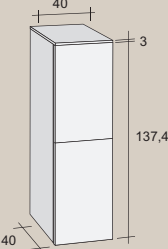
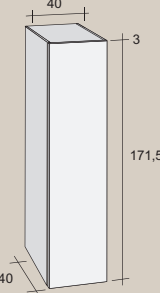

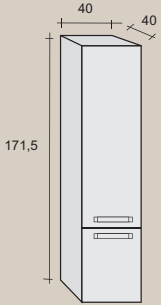
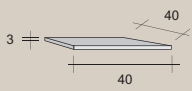
BRONI

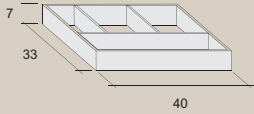
Zrcadlo Mirror Зеркало	60 	80 	100 	120 	140 	160 
Zrcadlo s osvětlením Mirror with lighting Зеркало со светом	60 	80 	100 	120 	140 	160 
Zrcadlová skříňka Mirror cabinet Шкафчик с зеркалом		80 	100 	120 	140 	
Zrcadlová skříňka Mirror cabinet Шкафчик с зеркалом	60 	80 	100 	120 	140 	160 
Osvětlení Lighting Освещение						
Police Shelf Полочка	60 	80 	100 	120 	140 	160 
Umyvadlo Wash basin Раковина	60 	80 	100 			
			100 			
			100 	120 	140 	160 
Umyvadlová skříňka Wash basin cabinet Шкафчик под раковину	60 	80 	100 	120 	140 	80 
Skříňka cabinet Шкафчик	  					

<p>Skříňka Cabinet Шкафчик</p>		
<p>Krycí deska Covering board Декоративная доска</p>		
<p>Sifon chromový Chrome siphon Разделение для выдвижного шкафчика</p>		
<p>Organizér zásuvky Drawer organizer Разделение для выдвижного шкафчика</p>		
<p>Výpust (Clic-Clac) Clic Clac Водослив для умывальника</p>		

EIFEL

Nábytek / Furniture / Мебель



Umyvadlo
Wash basin
Раковина

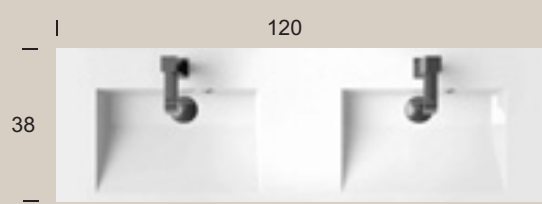
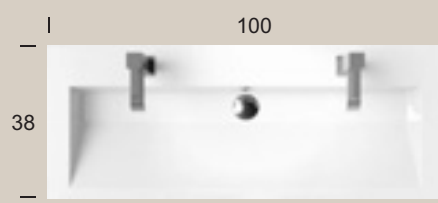

Barevné provedení
Colours
Расцветка

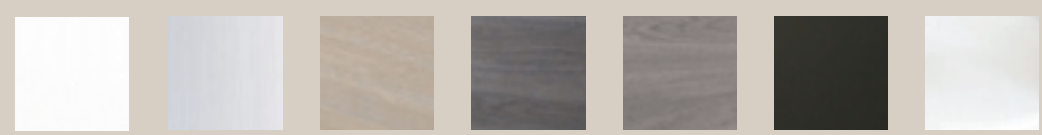

- | | | | | | | |
|------------------------|--|---------|---------|------|--|--|
| D00 | D10 | DEC | DCA | DOR | BLK | R01 |
| bílá
white
белая | bílá–struktura
white–structure
белая–структура | cremona | chateau | orme | černá–struktura
black–structure
чёрная–структура | bílá–lesk
white–shiny
белая–лоск |

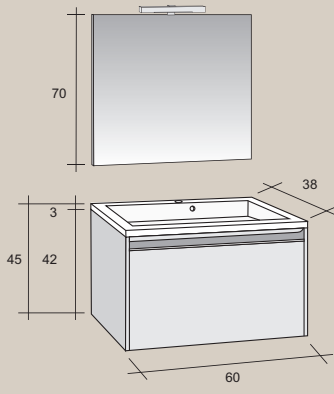

Set 01

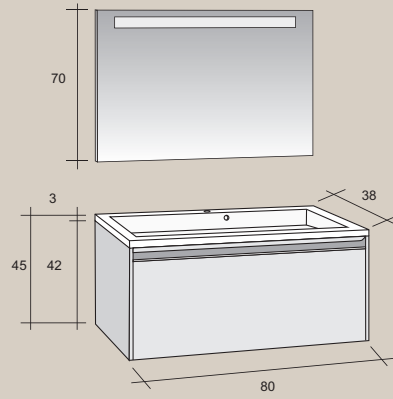

Set 05

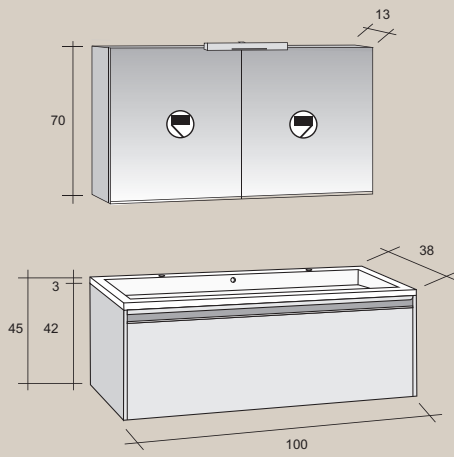



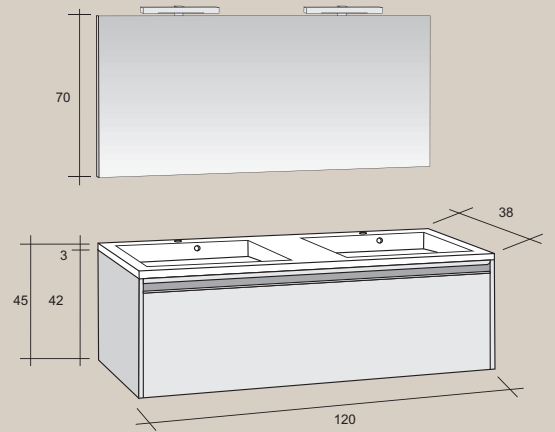

Set 09

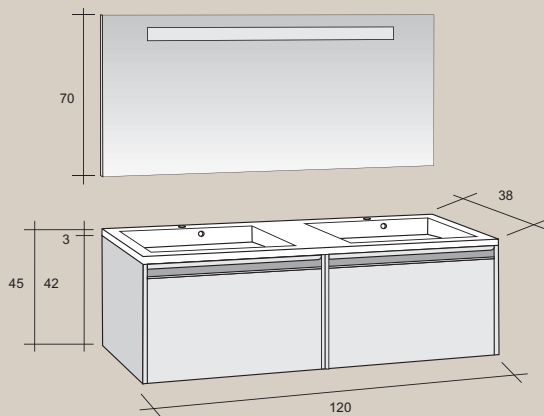

Set 10

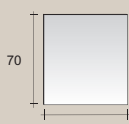
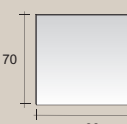
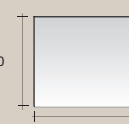
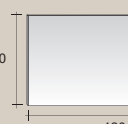
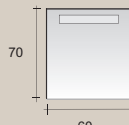
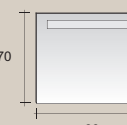
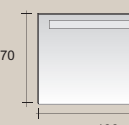
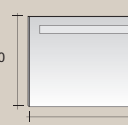
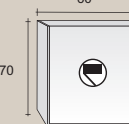
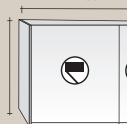
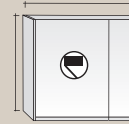
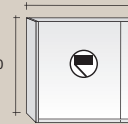
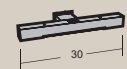

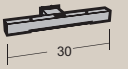
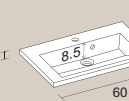
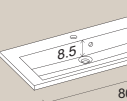
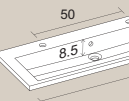
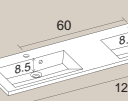
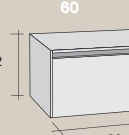
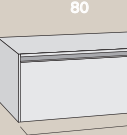
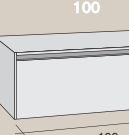
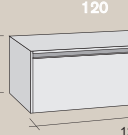
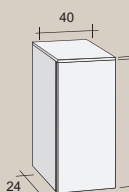
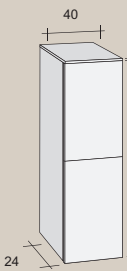
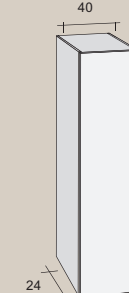
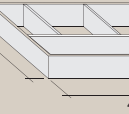
Set 14

<p>Zrcadlo Mirror Зеркало</p>	<p>60 70 60</p> 	<p>80 70 80</p> 	<p>100 70 100</p> 	<p>120 70 120</p> 
<p>Zrcadlo s osvětlením Mirror with lighting Зеркало со светом</p>	<p>70 60</p> 	<p>70 80</p> 	<p>70 100</p> 	<p>70 120</p> 
<p>Zrcadlová skříňka Mirror cabinet Шкафчик с зеркалом</p>	<p>60 13 70</p> 	<p>80 13 70</p> 	<p>100 13 70</p> 	<p>120 13 70</p> 
<p>Osvětlení Lighting Освещение</p>	 <p>30</p>			  <p>30 30</p>
<p>Umyvadlo Wash basin Раковина</p>	<p>3 l 38 8.5 60</p> 	<p>3 l 38 8.5 80</p> 	<p>3 l 38 50 8.5 100</p> 	<p>3 l 38 60 8.5 120</p> 
<p>Umyvadlová skříňka Wash basin cabinet Шкафчик под раковину</p>	<p>60 38 42 60</p> 	<p>80 38 42 80</p> 	<p>100 38 42 100</p> 	<p>120 38 42 120</p> 
<p>Skříňka Cabinet Шкафчик</p>	<p>40 1.8 24 96.8</p> 	<p>40 1.8 24 137.4</p> 	<p>40 171.5 24</p> 	
<p>Organizer zástavky Drawer organizer Разделение для выдвижного шкафчика</p>	<p>7 25 40</p> 			
<p>Výpusť (Clic-Clac) Clic Clac Водослив для умывальника</p>				

ELZAS





ELZAS



Umyvadlo
Wash basin
Раковина

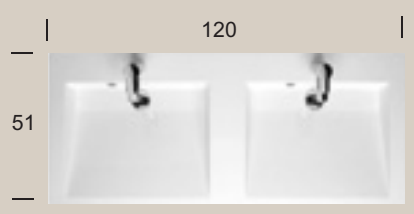
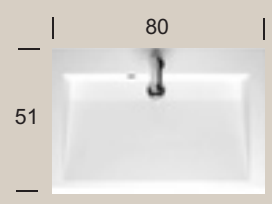

Barevné provedení
Colours
Расцветка

					
D00	D10	DEC	DCA	DOR	BLK
bílá white белая	bílá–struktura white–structure белая–структура	cremona	chateau	orme	černá–struktura black–structure чёрная–структура

ELZAS

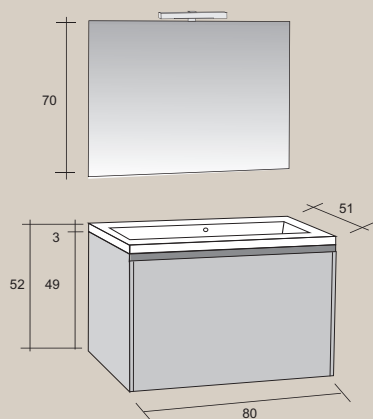



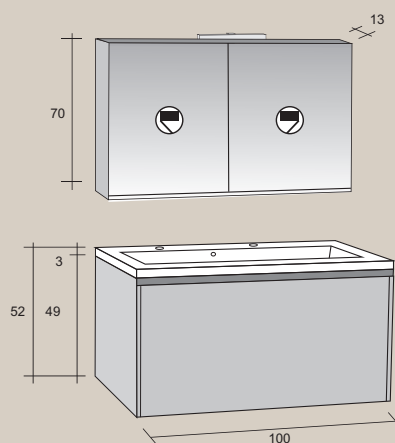

Set 01

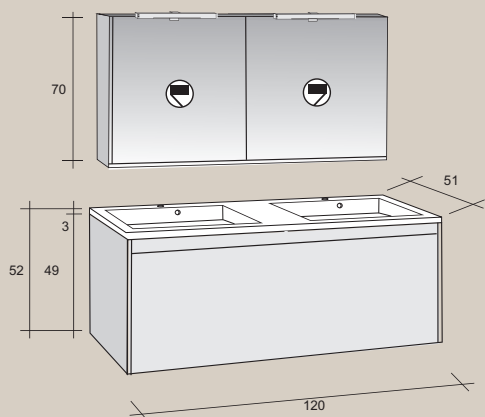

Set 06

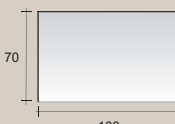
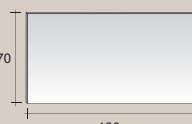
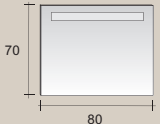
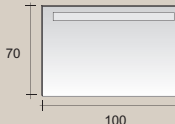
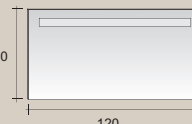
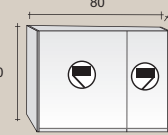
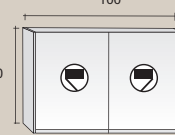
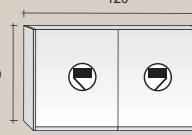

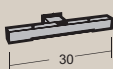
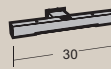
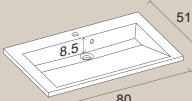
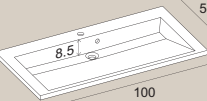
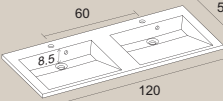
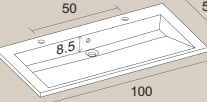
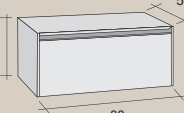
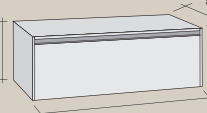
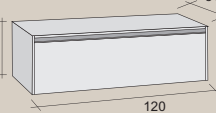
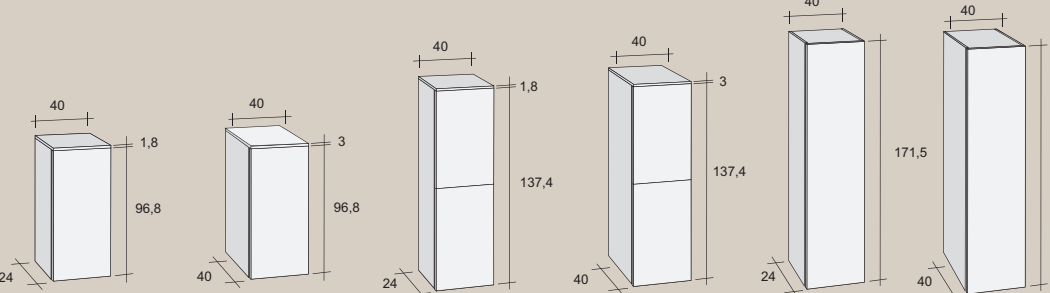
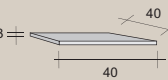
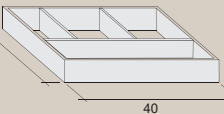
Set 09

<p>Zrcadlo Mirror Zrcadlo</p>	<p>80 </p>	<p>100 </p>	<p>120 </p>	
<p>Zrcadlo s osvětlením Mirror with lighting Зеркало со светом</p>	<p>80 </p>	<p>100 </p>	<p>120 </p>	
<p>Zrcadlová skříňka Mirror cabinet Шкафчик с зеркалом</p>	<p>80 13 70 </p>	<p>100 13 70 </p>	<p>120 13 70 </p>	
<p>Osvětlení Lighting Освещение</p>	<p></p>		<p> </p>	
<p>Umyvadlo Wash basin Раковина</p>	<p>80 51 8.5 3 I </p>	<p>100 51 8.5 3 I </p>	<p>120 51 8.5 3 I </p>	
		<p>50 51 8.5 3 I </p>		
<p>Umyvadlová skříňka Wash basin cabinet Шкафчик под раковину</p>	<p>80 51 49 </p>	<p>100 51 49 </p>	<p>120 51 49 </p>	
<p>Skříňka Cabinet Шкафчик</p>	<p></p>			
<p>Krycí deska Covering board Декоративная доска</p>	<p></p>			
<p>Organizer zástavky Drawer organizer Разделение для выдвижного шкафчика</p>	<p></p>			
<p>Výpusť (Clic-Clac) Clic Clac Водослив для умывальника</p>	<p></p>			



Umyvadlo
Wash basin
Раковина

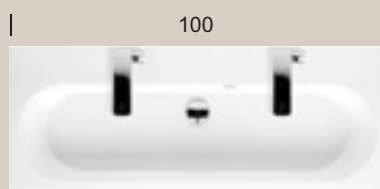
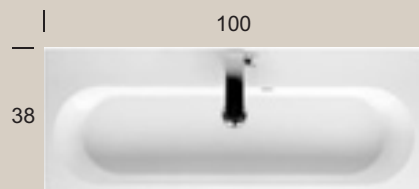
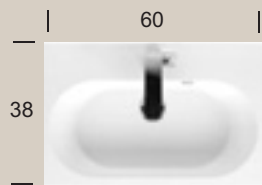

Barevné provedení
Colours
Расцветка

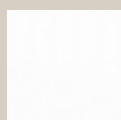

D00

bílá
white
белая



D10

bílá-struktura
white-structure
белая-структура

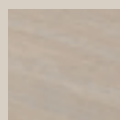

DEC

cremona

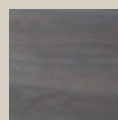

DCA

chateau

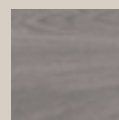

DOR

orme

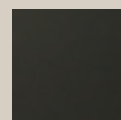

BLK

černá-struktura
black-structure
чёрная-структура



R01

bílá-lesk
white-shiny
белая-поск

ESTÉE

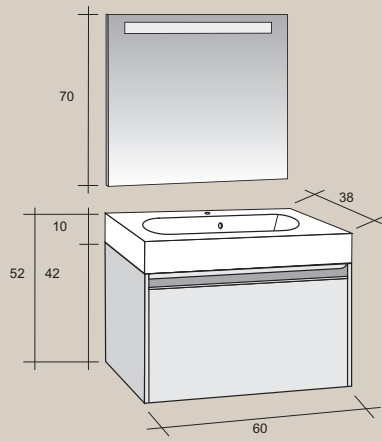

Set 01

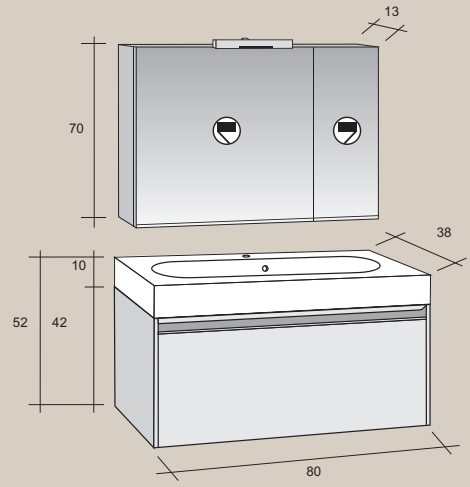



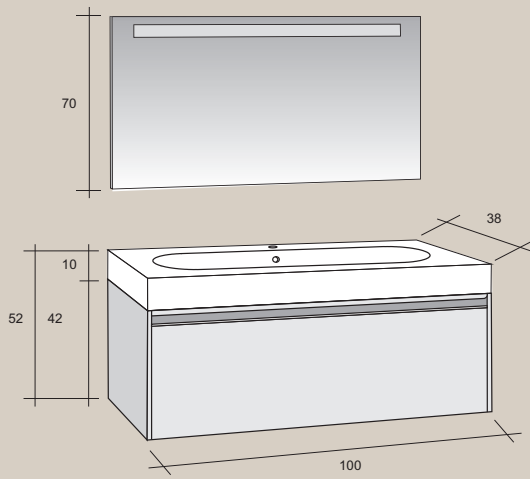



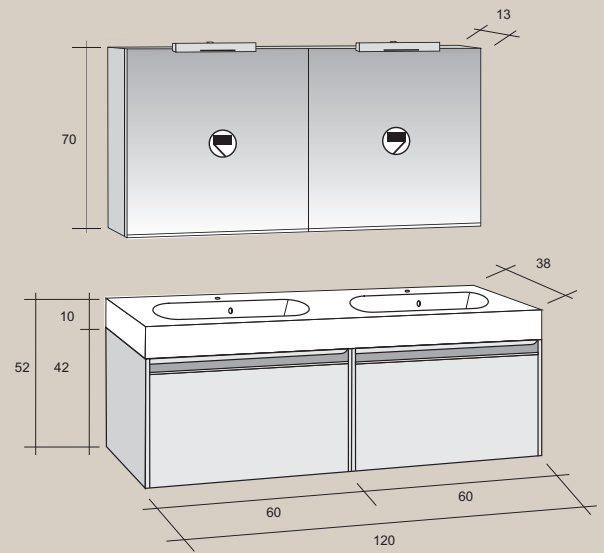



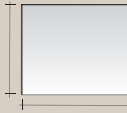
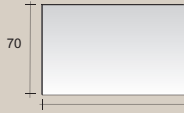
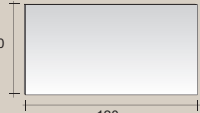
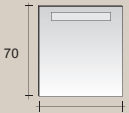
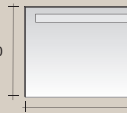
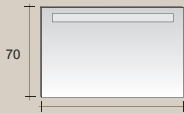
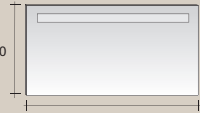
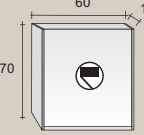
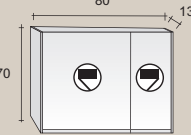
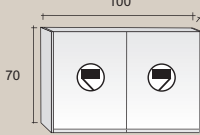

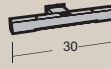
Set 06

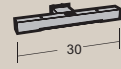

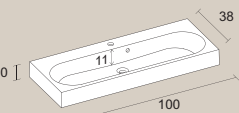
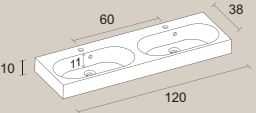
Set 10

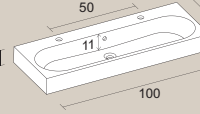

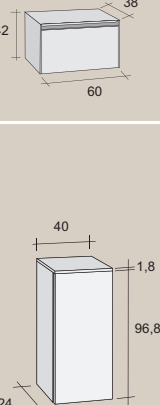
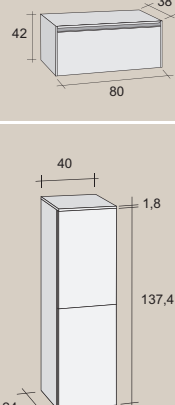
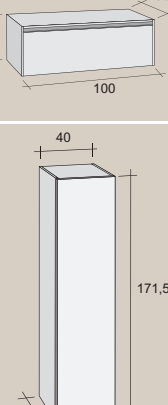
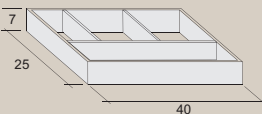
Set 21

<p>Zrcadlo Mirror Зеркало</p>	<p>60 70 60</p> 	<p>80 70 80</p> 	<p>100 70 100</p> 	<p>120 70 120</p> 
<p>Zrcadlo s osvětlením Mirror with lighting Зеркало со светом</p>	<p>60 70 60</p> 	<p>80 70 80</p> 	<p>100 70 100</p> 	<p>120 70 120</p> 
<p>Zrcadlová skříňka Mirror cabinet Шкафчик с зеркалом</p>	<p>60 13 70</p> 	<p>80 13 70</p> 	<p>100 13 70</p> 	<p>120 13 70</p> 
<p>Osvětlení Lighting Освещение</p>	 <p>30</p>			  <p>30 30</p>
<p>Umyvadlo Wash basin Раковина</p>	<p>10 38 60</p> 	<p>10 38 80</p> 	<p>10 38 100</p> 	<p>10 38 60 120</p> 
<p>Umyvadlová skříňka Wash basin cabinet Шкафчик под раковину</p>	<p>42 38 60</p> 	<p>42 38 80</p> 	<p>42 38 100</p> 	<p>42 38 60 60</p> 
<p>Skříňka Cabinet Шкафчик</p>	<p>40 1,8 96,8 24</p> 	<p>40 1,8 137,4 24</p> 	<p>40 171,5 24</p> 	
<p>Organizer zástavky Drawer organizer Разделение для выдвигающего шкафчика</p>	<p>7 25 40</p> 			
<p>Výpusť (Clic-Clac) Clic Clac Водослив для умывальника</p>				



Umyvadlo
Wash basin
Раковина

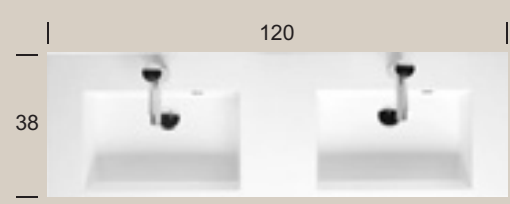
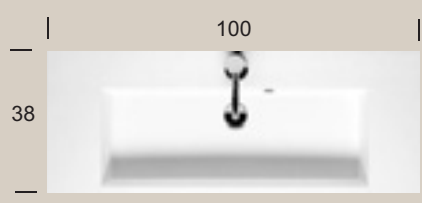
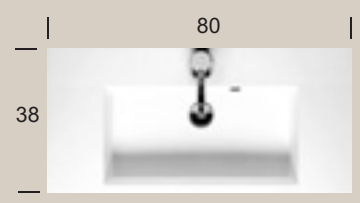

Barevné provedení
Colours
Расцветка



D00

bílá
white
белая



D10

bílá-struktura
white-structure
белая-структура

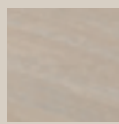

DEC

cremona

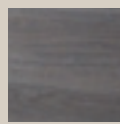

DCA

chateau

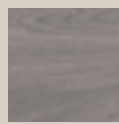

DOR

orme

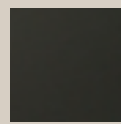

BLK

černá-struktura
black-structure
чёрная-структура



R01

bílá-lesk
white-shiny
белая-лоск

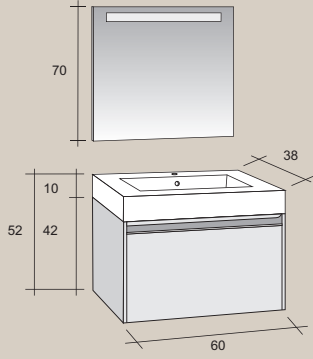

Set 01

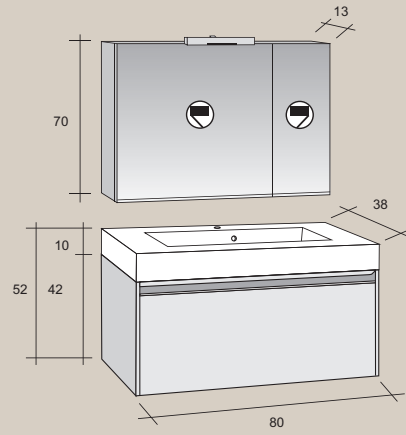



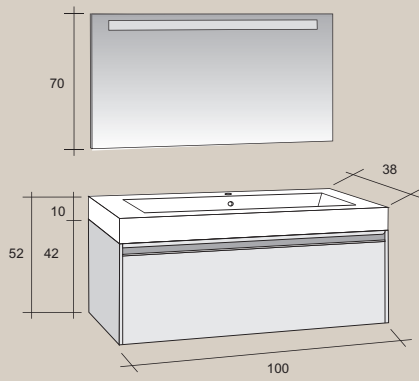



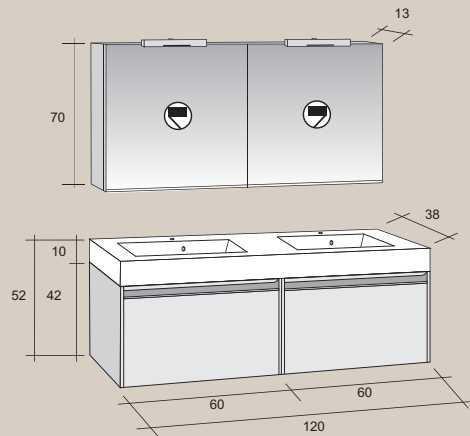

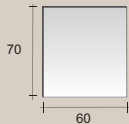
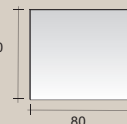
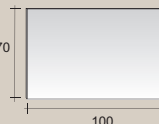
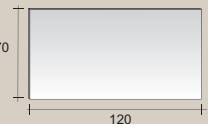
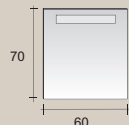
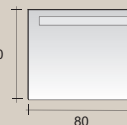
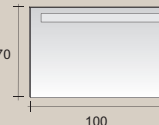
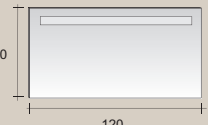
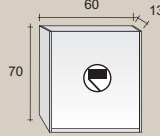
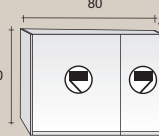
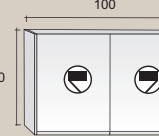

Set 06

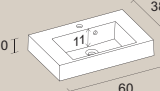

Set 10

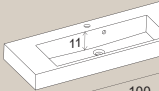
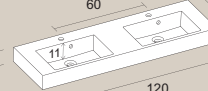
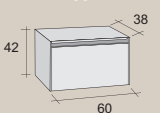
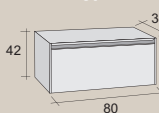
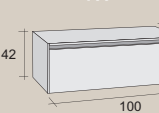
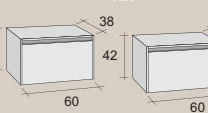
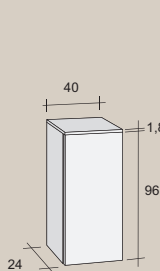
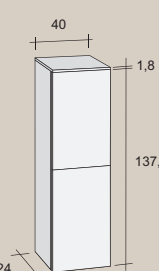
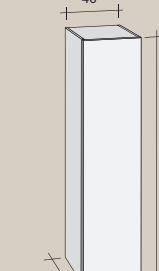

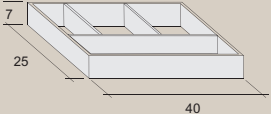
Set 21

<p>Zrcadlo Mirror Zrcadlo</p>	<p>60 </p>	<p>80 </p>	<p>100 </p>	<p>120 </p>
<p>Zrcadlo s osvětlením Mirror with lighting Зеркало со светом</p>	<p>60 </p>	<p>80 </p>	<p>100 </p>	<p>120 </p>
<p>Zrcadlová skříňka Mirror cabinet Шкафчик с зеркалом</p>	<p>60 13 </p>	<p>80 13 </p>	<p>100 13 </p>	<p>120 13 </p>
<p>Osvětlení Lighting Освещение</p>	<p></p>			<p> </p>
<p>Umyvadlo Wash basin Раковина</p>	<p>60 38 11 </p>	<p>80 38 11 </p>	<p>100 38 11 </p>	<p>120 38 11 </p>
<p>Umyvadlová skříňka Wash basin cabinet Шкафчик под раковину</p>	<p>60 38 42 </p>	<p>80 38 42 </p>	<p>100 38 42 </p>	<p>120 38 42 </p>
<p>Skříňka Cabinet Шкафчик</p>	<p>40 1.8 96.8 24 </p> <p>40 1.8 137.4 24 </p> <p>40 171.5 24 </p>			<p></p>
<p>Organizer zástuvky Drawer organizer Разделение для выдвижного шкафчика</p>	<p>7 25 40 </p>			
<p>Výpust (Clic-Clac) Clic Clac Водослив для умывальника</p>	<p></p>			

LIGNA





LIGNA

Umyvadlo
Wash basin
Раковина



Barevné provedení
Colours
Расцветка

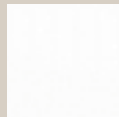

D00

bílá
white
белая



D10

bílá-struktura
white-structure
белая-структура

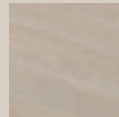

DEC

cremona

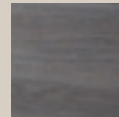

DCA

chateau

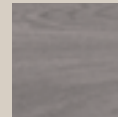

DOR

orme

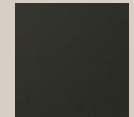

BLK

černá-struktura
black-structure
чёрная-структура

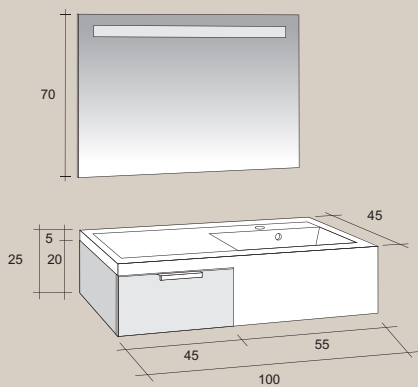

Set 15

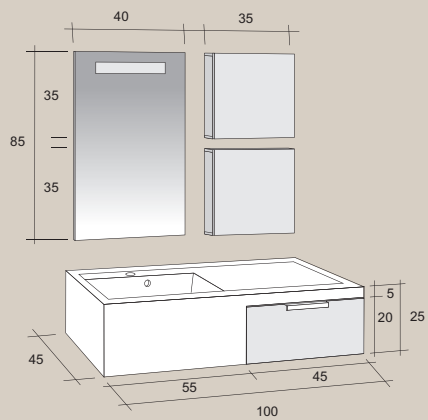

Set 12

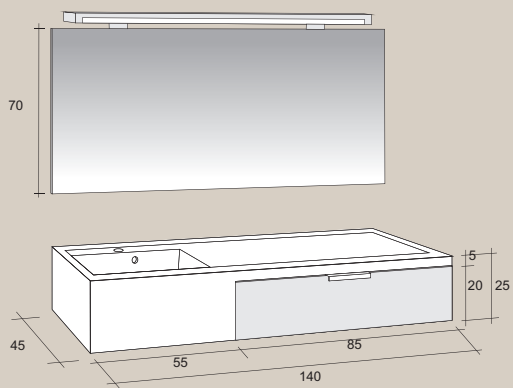



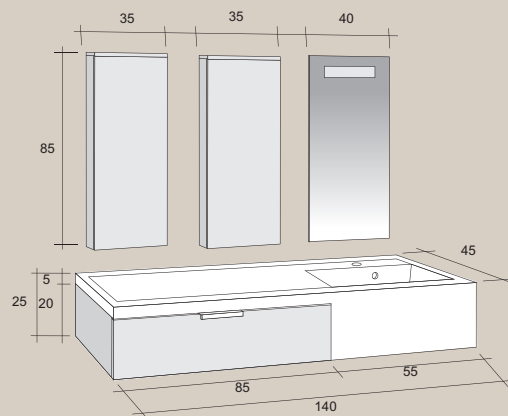





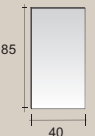

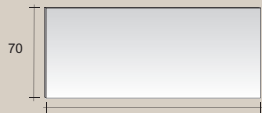
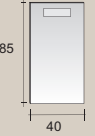
Set 21

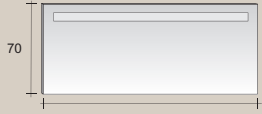
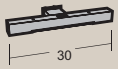

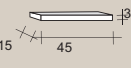
Set 24

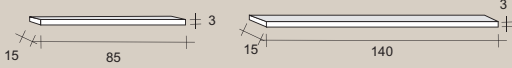
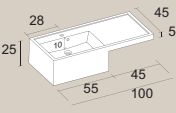
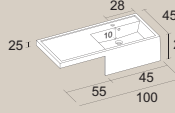
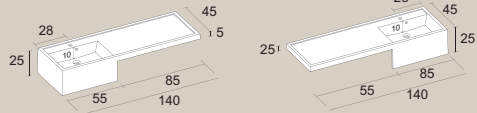
LIGNA

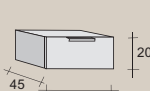
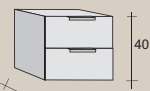
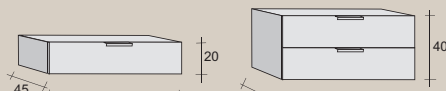
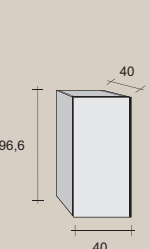
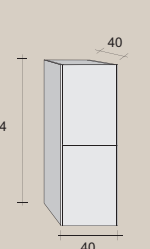
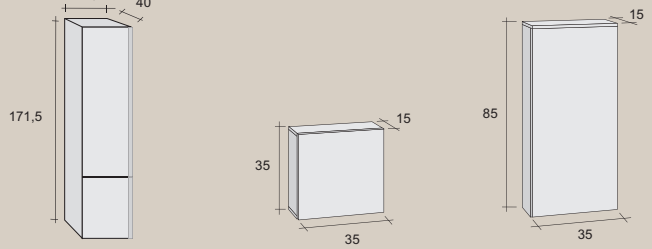
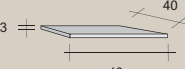
<p>Zrcadlo Mirror Зеркало</p>	<p>40 85 40</p> 	<p>100 70 100</p> 	<p>140 70 140</p> 
<p>Zrcadlo s osvětlením Mirror with lighting Зеркало со светом</p>	<p>85 40</p> 	<p>70 100</p> 	<p>70 140</p> 
<p>Osvětlení Lighting Освещение</p>	<p>30</p> 	<p>100</p> 	<p>140</p> 
<p>Police Shelf Полочка</p>	<p>45 15 45</p> 	<p>100 15 100</p> 	<p>85 140 15 85 15 140</p> 
<p>Umyvadlo Wash basin Раковина</p>	<p>28 45 5 25 55 45 100</p> 	<p>28 45 5 25 55 45 100</p> 	<p>28 45 5 25 55 85 140 10 45 25 85 140</p> 
<p>Výpust (Clic-Clac) Clic Clac Водослив для умывальника</p>			
<p>Umyvadlová skříňka Wash basin cabinet Шкафчик под раковину</p>	<p>45 45 20</p> 	<p>45 45 40</p> 	<p>45 85 20 45 85 40</p> 
<p>Skříňka Cabinet Шкафчик</p>	<p>96,6 40 40</p> 	<p>137,4 40 40</p> 	<p>171,5 40 40 35 15 85 35</p> 
<p>Krycí deska Covering board Декоративная доска</p>	<p>3 40 40</p> 		



LUCCA





Umývadlo
Wash basin
Раковина

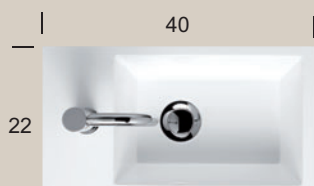

Barevné provedení
Colours
Расцветка

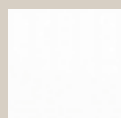

D00

bílá
white
белая



D10

bílá-struktura
white-structure
белая-структура

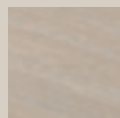

DEC

cremona

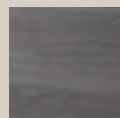

DCA

chateau

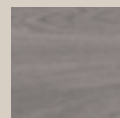

DOR

orme

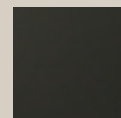

BLK

černá-struktura
black-structure
чёрная-структура



R01

bílá-lesk
white-shiny
белая-лоск

LUCCA

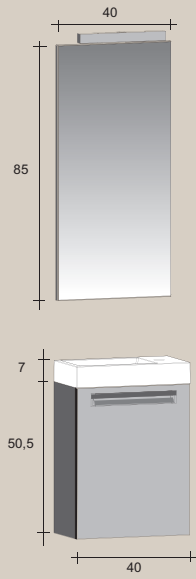

Set 01

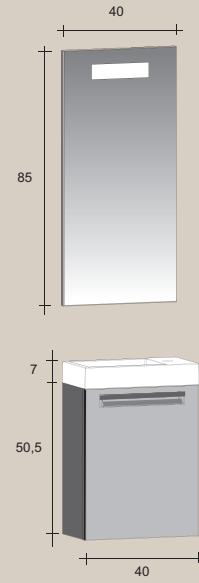

Set 02

Zrcadlo
Mirror
Зеркало

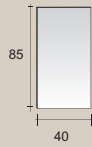

Zrcadlo s osvětlením
Mirror with lighting
Зеркало со светом



Osvětlení
Lighting
Освещение

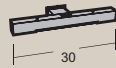

Umyvadlo
Wash basin
Раковина

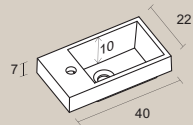

Skříňka
Cabinet
Шкафчик

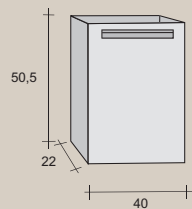



SLIMLINE





SLIMLINE



Umyvadlo
Wash basin
Раковина

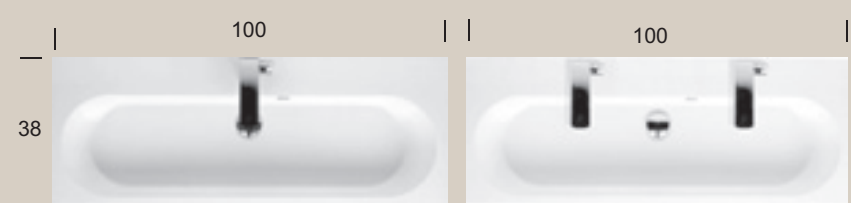
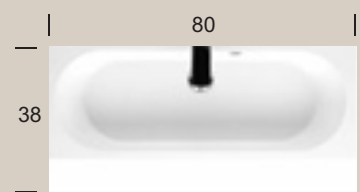

Barevné provedení
Colours
Расцветка



D00	D10	DEC	DCA	DOR	BLK	R01
bílá white белая	bílá-struktura white-structure белая-структура	cremona	chateau	orme	černá-struktura black-structure чёрная-структура	bílá-lesk white-shiny белая-лоск

SLIMLINE

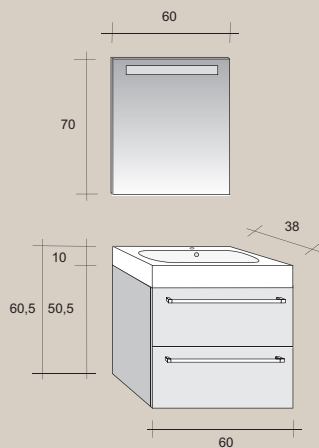

Set 01

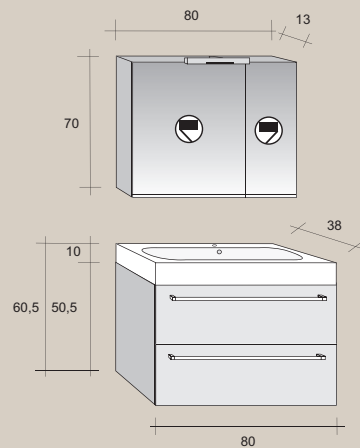

Set 06

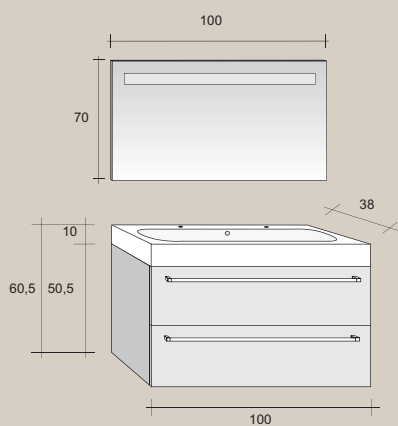

Set 15

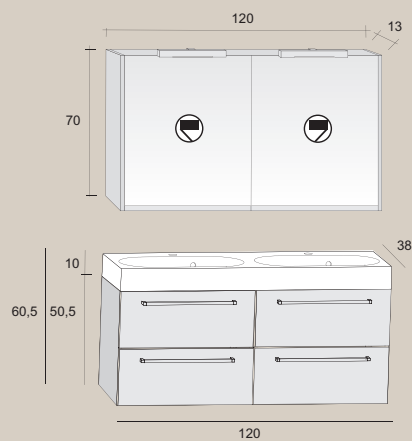



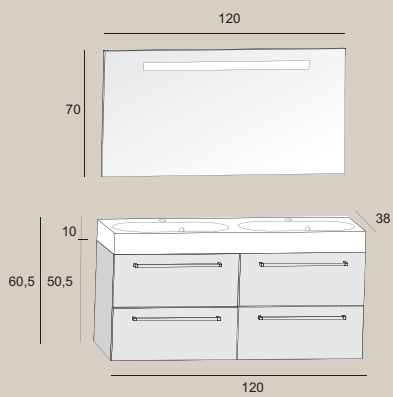

Set 21

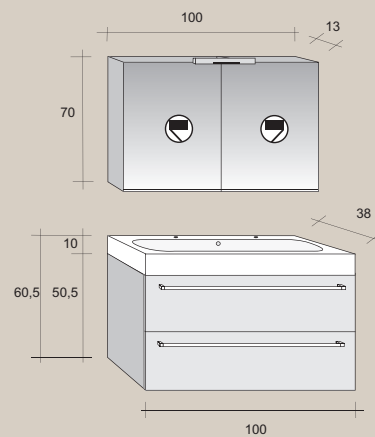

Set 20

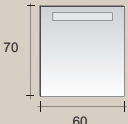
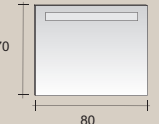
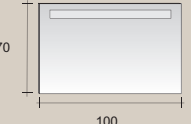
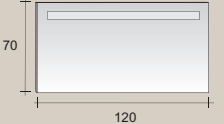
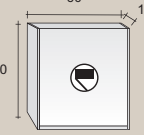
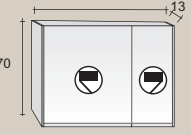
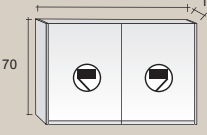
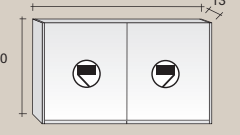
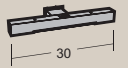
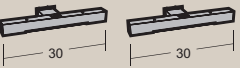

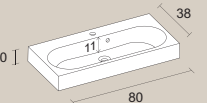
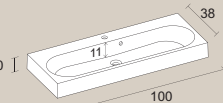
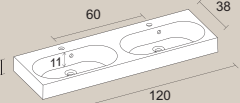
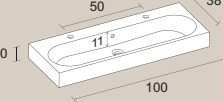
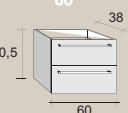
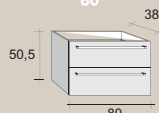
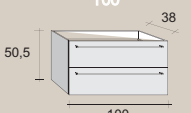
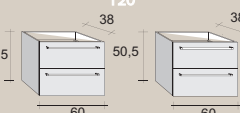
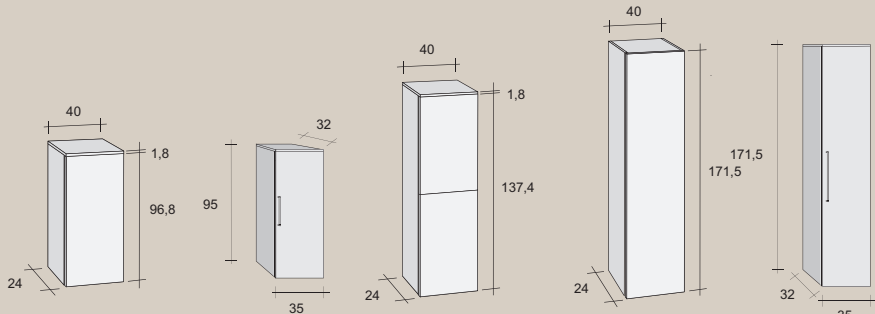
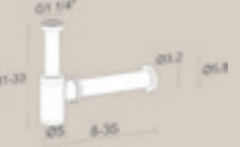
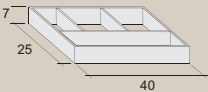
Set 16

<p>Zrcadlo s osvětlením Mirror with lighting Зеркало со светом</p>	<p>60 70 60</p> 	<p>80 70 80</p> 	<p>100 70 100</p> 	<p>120 70 120</p> 
<p>Zrcadlová skříňka Mirror cabinet Шкафчик с зеркалом</p>	<p>60 13 70</p> 	<p>80 13 70</p> 	<p>100 13 70</p> 	<p>120 13 70</p> 
<p>Osvětlení Lighting Освещение</p>	 <p>30</p>			 <p>30 30</p>
<p>Umyvadlo Wash basin Раковина</p>	<p>10 38 60</p> 	<p>10 38 80</p> 	<p>10 38 100</p> 	<p>10 38 60 120</p> 
	 <p>10 38 50 100</p>			
<p>Umyvadlová skříňka Wash basin cabinet Шкафчик под раковину</p>	<p>60 38 50,5 60</p> 	<p>80 38 50,5 80</p> 	<p>100 38 50,5 100</p> 	<p>120 38 50,5 50,5 60 60</p> 
<p>Skříňka Cabinet Шкафчик</p>	 <p>40 1,8 96,8 24 32 95 35 40 1,8 137,4 24 40 171,5 24 32 171,5 35</p>			
<p>Sifon chromový Chrome siphon Сифон хромовый</p>	 <p>Ø1 1/4" 11-33 Ø3,2 Ø5,4 8-35</p>			
<p>Organizer zástavky Drawer organizer Разделение для выдвижного шкафчика</p>	 <p>7 25 40</p>			
<p>Výpust (Clic-Clac) Clic Clac Водослив для умывальника</p>				

SMARTLINE

Nábytek / Furniture / Мебель





SMARTLINE



Umyvadlo
Wash basin
Раковина

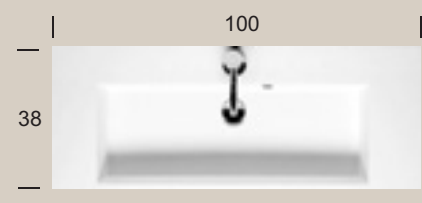
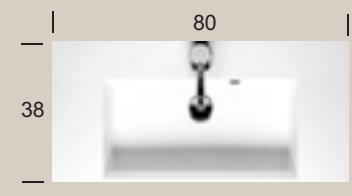
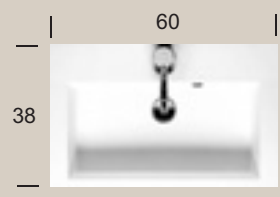

Barevné provedení
Colours
Расцветка



D00

bílá
white
белая



D10

bílá-struktura
white-structure
белая-структура

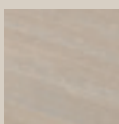

DEC

cremona

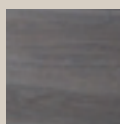

DCA

chateau

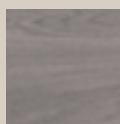

DOR

orme

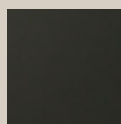

BLK

černá-struktura
black-structure
чёрная-структура



R01

bílá-lesk
white-shiny
белая-лоск

SMARTLINE



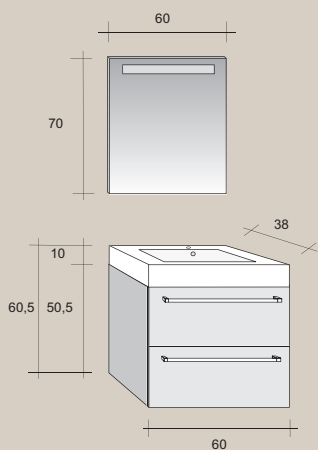

Set 01

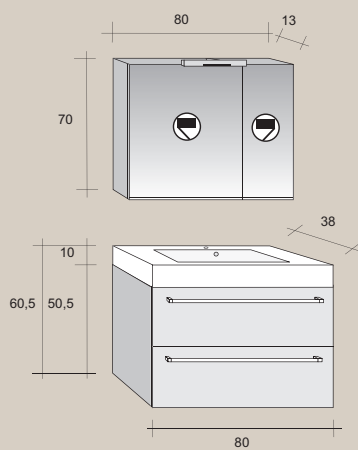

Set 06

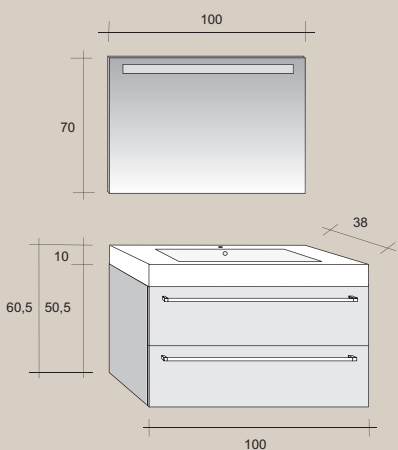

Set 10

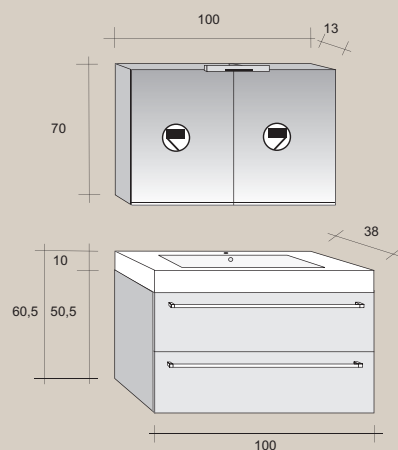

Set 11

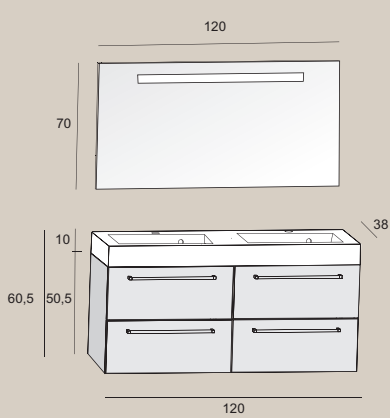



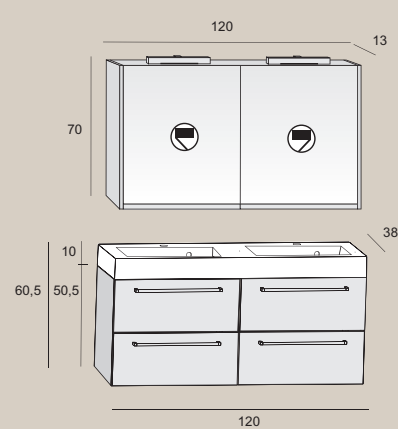





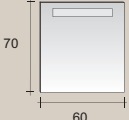
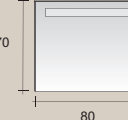

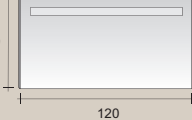
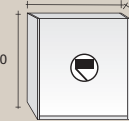
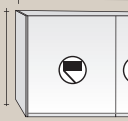
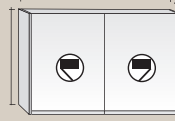
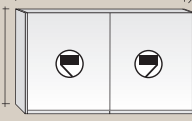
Set 20

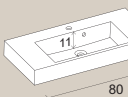
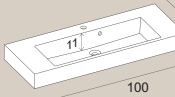
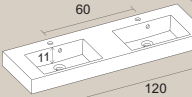
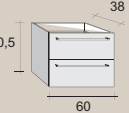
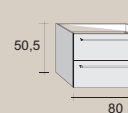
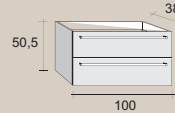
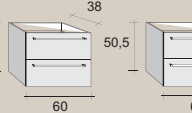
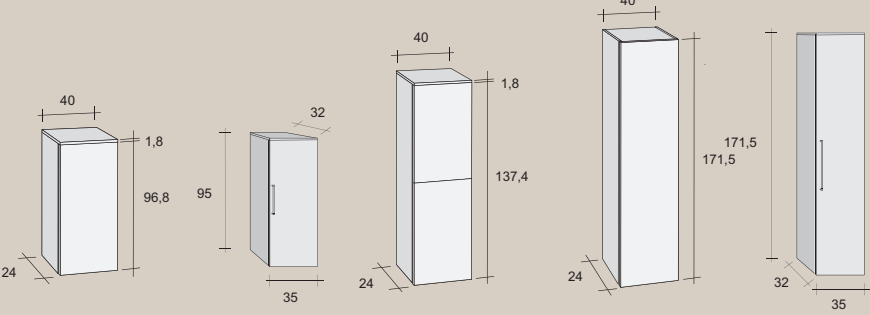

Set 21

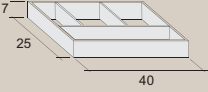
SMARTLINE

<p>Zrcadlo s osvětlením Mirror with lighting Зеркало со светом</p>	<p>60 70 60</p> 	<p>80 70 80</p> 	<p>100 70 100</p> 	<p>120 70 120</p> 
<p>Zrcadlová skříňka Mirror cabinet Шкафчик с зеркалом</p>	<p>60 70 13 60</p> 	<p>80 70 13 80</p> 	<p>100 70 13 100</p> 	<p>120 70 13 120</p> 
<p>Osvětlení Lighting Освещение</p>	 <p>30</p>			 <p>30</p>  <p>30</p>
<p>Umyvadlo Wash basin Раковина</p>	<p>10 38 60</p> 	<p>10 38 80</p> 	<p>10 38 100</p> 	<p>10 38 60 120</p> 
<p>Umyvadlová skříňka Wash basin cabinet Шкафчик под раковину</p>	<p>50,5 38 60</p> 	<p>50,5 38 80</p> 	<p>50,5 38 100</p> 	<p>50,5 38 60 60</p> 
<p>Skříňka Cabinet Шкафчик</p>				
<p>Sifon chromový Chrome chrome siphon Сифон хромовый</p>				
<p>Organizer zástavky Drawer organizer Разделение для выдвижного шкафчика</p>				
<p>Výpust (Clic-Clac) Clic Clac Водослив для умывальника</p>				



SCALA



Umyvadlo
Wash basin
Раковина



Barevné provedení
Colours
Расцветка



D00	D10	DEC	DCA	DOR	BLK	R01
bílá white белая	bílá-struktura white-structure белая-структура	cremona	chateau	orme	černá-struktura black-structure чёрная-структура	bílá-lesk white-shiny белая-лоск

SCALA

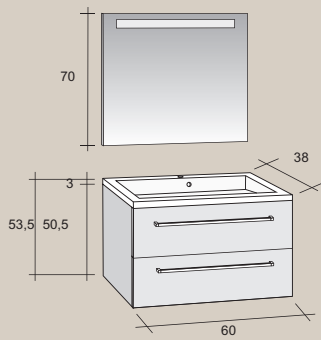

Set 01

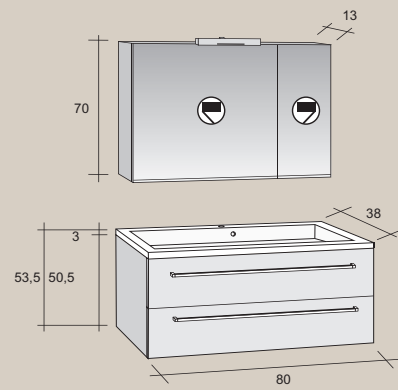



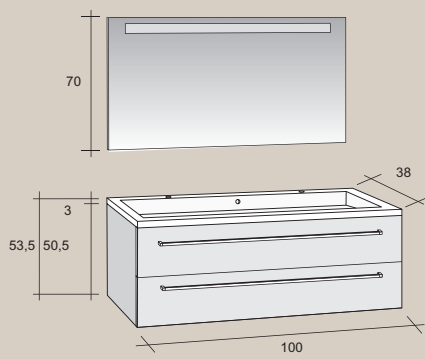

Set 06

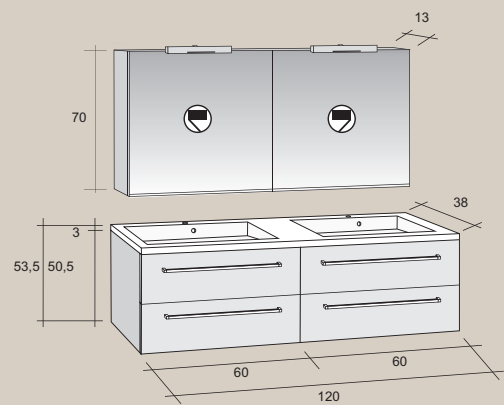

Set 15

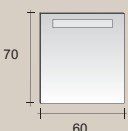
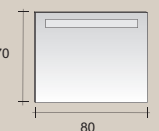
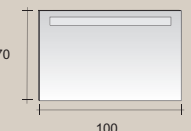
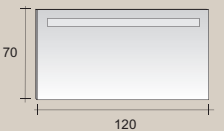
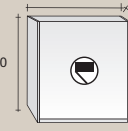
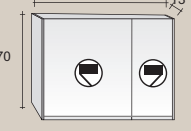
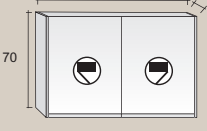
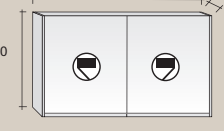

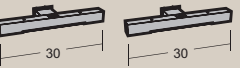
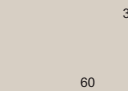
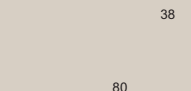
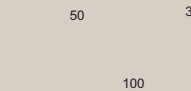
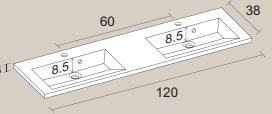
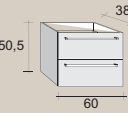
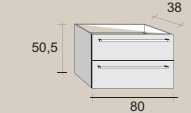
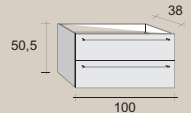
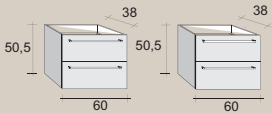
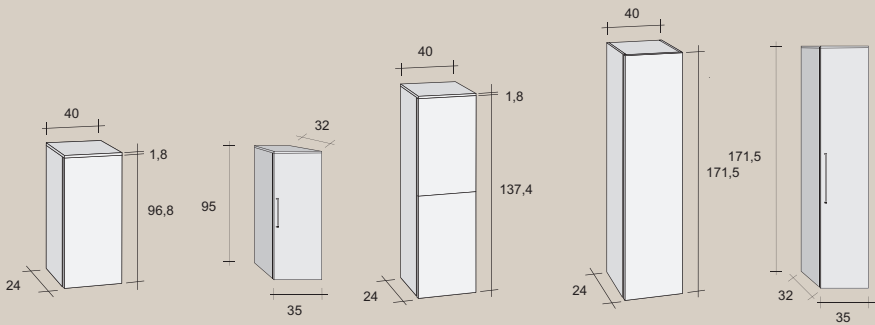
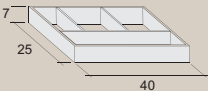
Set 21

<p>Zrcadlo s osvětlením Mirror with lighting Зеркало со светом</p>	<p>60 70 60</p> 	<p>80 70 80</p> 	<p>100 70 100</p> 	<p>120 70 120</p> 
<p>Zrcadlová skříňka Mirror cabinet Шкафчик с зеркалом</p>	<p>60 70 13</p> 	<p>80 70 13</p> 	<p>100 70 13</p> 	<p>120 70 13</p> 
<p>Osvětlení Lighting Освещение</p>	 <p>30</p>			 <p>30 30</p>
<p>Umyvadlo Wash basin Раковина</p>	<p>3 38 60</p> 	<p>3 38 80</p> 	<p>3 38 100</p> 	<p>3 38 60 8,5 120</p> 
<p>Umyvadlová skříňka Wash basin cabinet Шкафчик под раковину</p>	<p>60 38 50,5 60</p> 	<p>80 38 50,5 80</p> 	<p>100 38 50,5 100</p> 	<p>120 38 50,5 60 50,5 60</p> 
<p>Skříňka Cabinet Шкафчик</p>				
<p>Organizer zástavky Drawer organizer Разделение для выдвижного шкафчика</p>				
<p>Výpust (Clic-Clac) Clic Clac Водослив для умывальника</p>				

VOLANO



Umyvadlo
Wash basin
Раковина

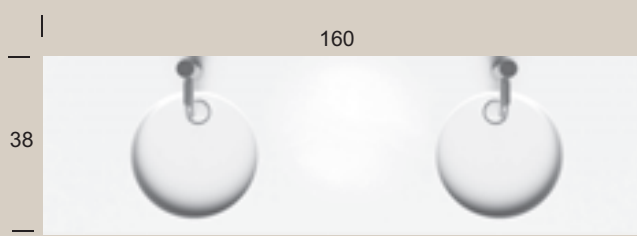
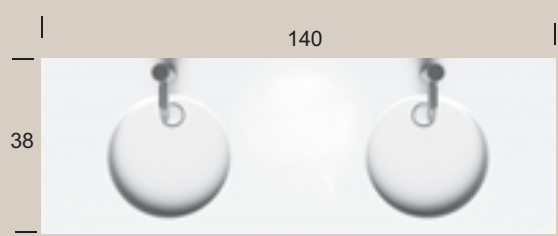
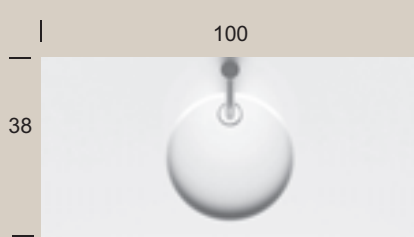
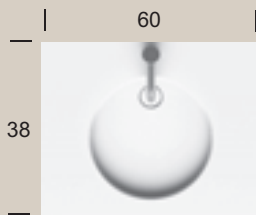

Barevné provedení
Colours
Расцветка

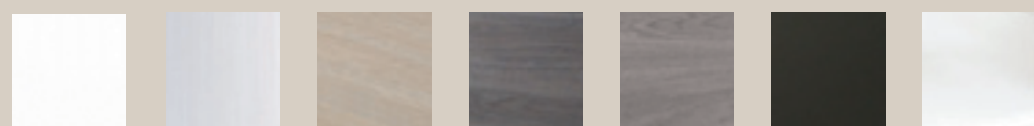

D00	D10	DEC	DCA	DOR	BLK	R01
bílá white белая	bílá–struktura white–structure белая–структура	cremona	chateau	orme	černá–struktura black–structure чёрная–структура	bílá–lesk white–shiny белая–лоск

VOLANO

Nábytek / Furniture / Мебель

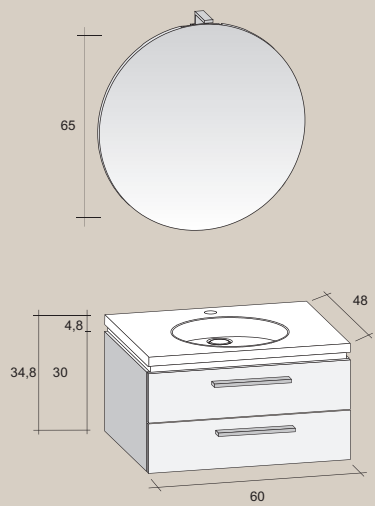

Set 02

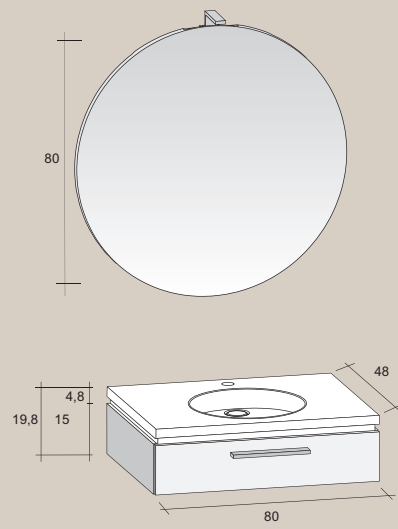

Set 05

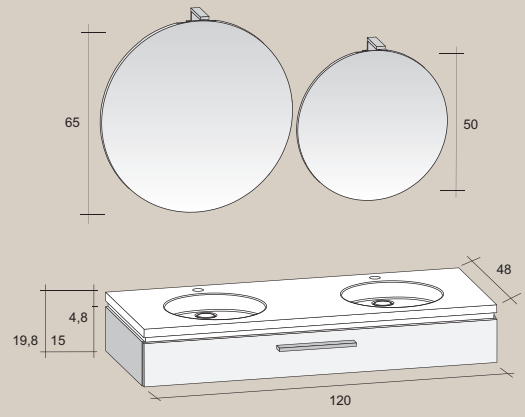

Set 15

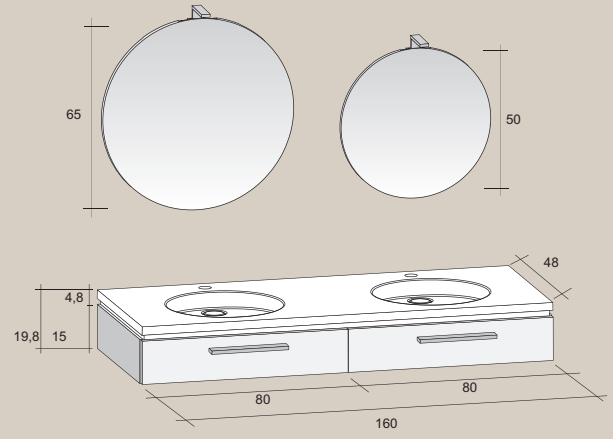

Set 25

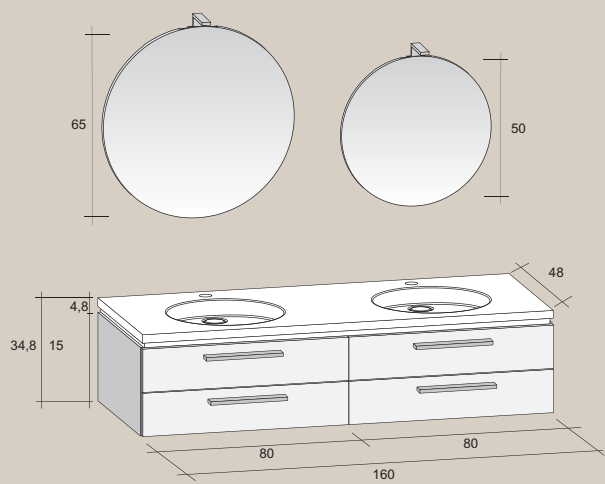

Set 26

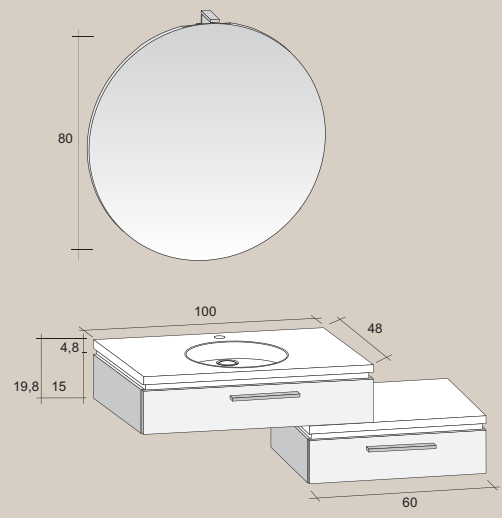





Set 35

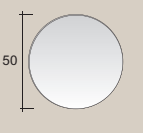
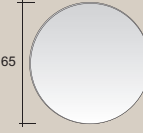
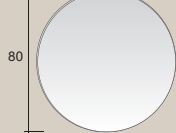
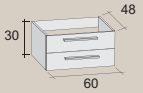
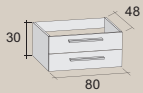
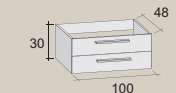
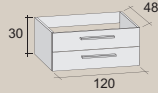
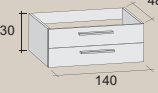
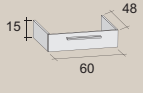
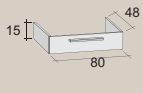
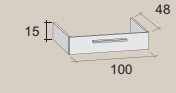
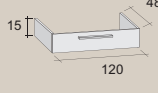
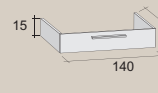
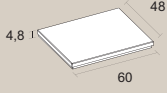
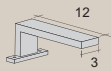
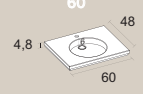
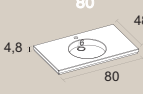
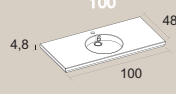
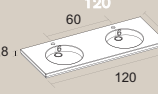
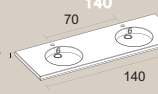
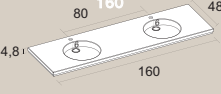
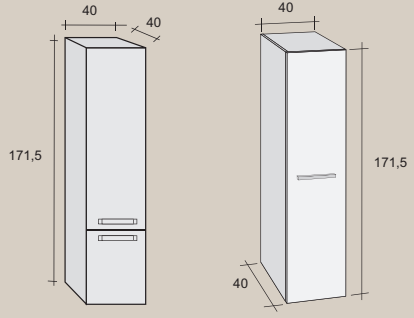
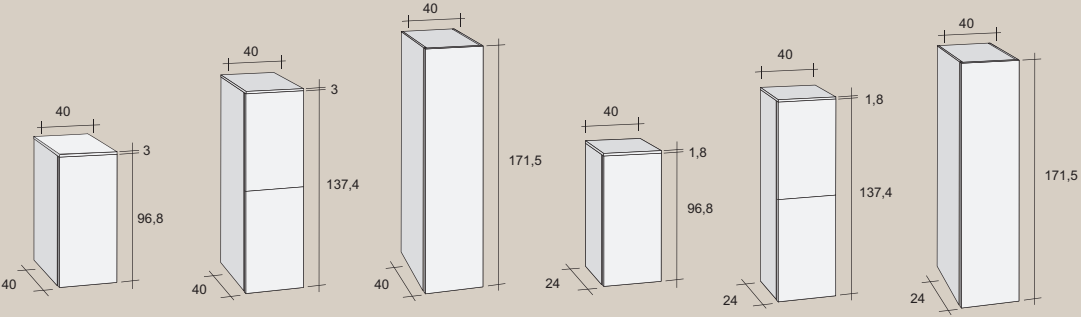

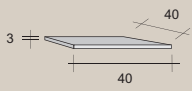
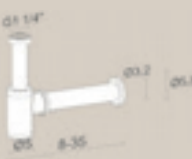
VOLANO

<p>Zrcadlo Mirror Зеркало</p>	<p>50</p> 	<p>65</p> 	<p>80</p> 			
<p>Umyvadlová skříňka Wash basin cabinet Шкафчик под раковину</p>	<p>60</p> 	<p>80</p> 	<p>100</p> 	<p>120</p> 	<p>140</p> 	
<p>Umyvadlová skříňka Wash basin cabinet Шкафчик под раковину</p>	<p>60</p> 	<p>80</p> 	<p>100</p> 	<p>120</p> 	<p>140</p> 	
<p>Krycí deska na umyvadlovou skříňku Cover desk on wash basin cabinet Декоративная доска для шкафчика под раковину</p>						
<p>Osvětlení Lighting Освещение</p>						
<p>Umyvadlo Wash basin Раковина</p>	<p>60</p> 	<p>80</p> 	<p>100</p> 	<p>120</p> 	<p>140</p> 	<p>160</p> 
<p>Skříňka cabinet Шкафчик</p>						
<p>Skříňka cabinet Шкафчик</p>						

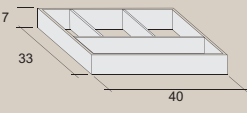
<p>Krycí deska Covering board Декоративная доска</p>		
<p>Sifon chromový Chrome siphon Разделение для выдвижного шкафчика</p>		
<p>Mistospořicí sifon Space-saving siphon Сифон экономит место</p>		
<p>Výpust (Clic-Clac) Clic Clac Водослив для умывальника</p>		 <p><i>Special (nízký)</i> <i>Special (low)</i> <i>Специальный (низкий)</i></p>
<p>Organizér zásuvky Drawer organizer Разделение для выдвижного шкафчика</p>		

AVANTI



Umyvadlo
Wash basin
Раковина

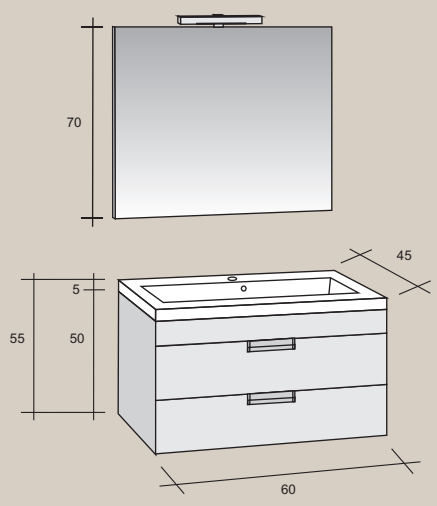
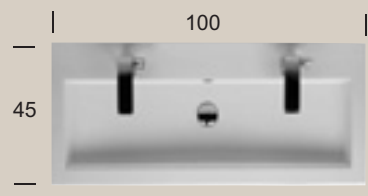
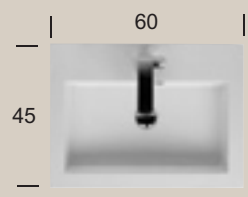

Set 01

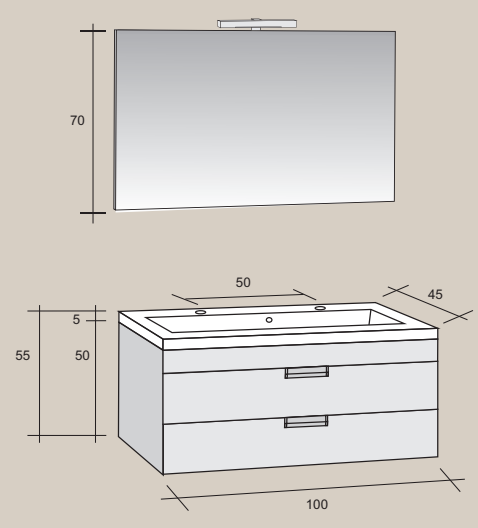

Set 03

Umyvadlo
Wash basin
Раковина

Skříňka
Cabinet
Шкафчик

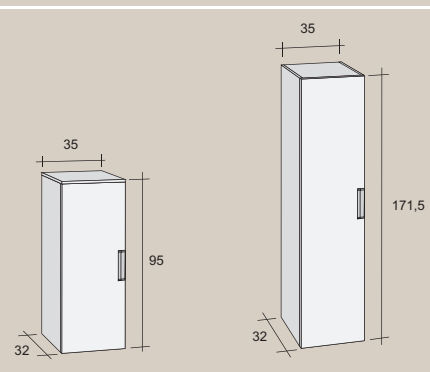

Barevné provedení
Colours
Расцветка

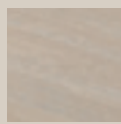

DEC

cremona

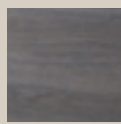

DCA

chateau

Poznámky / Notes / Записки

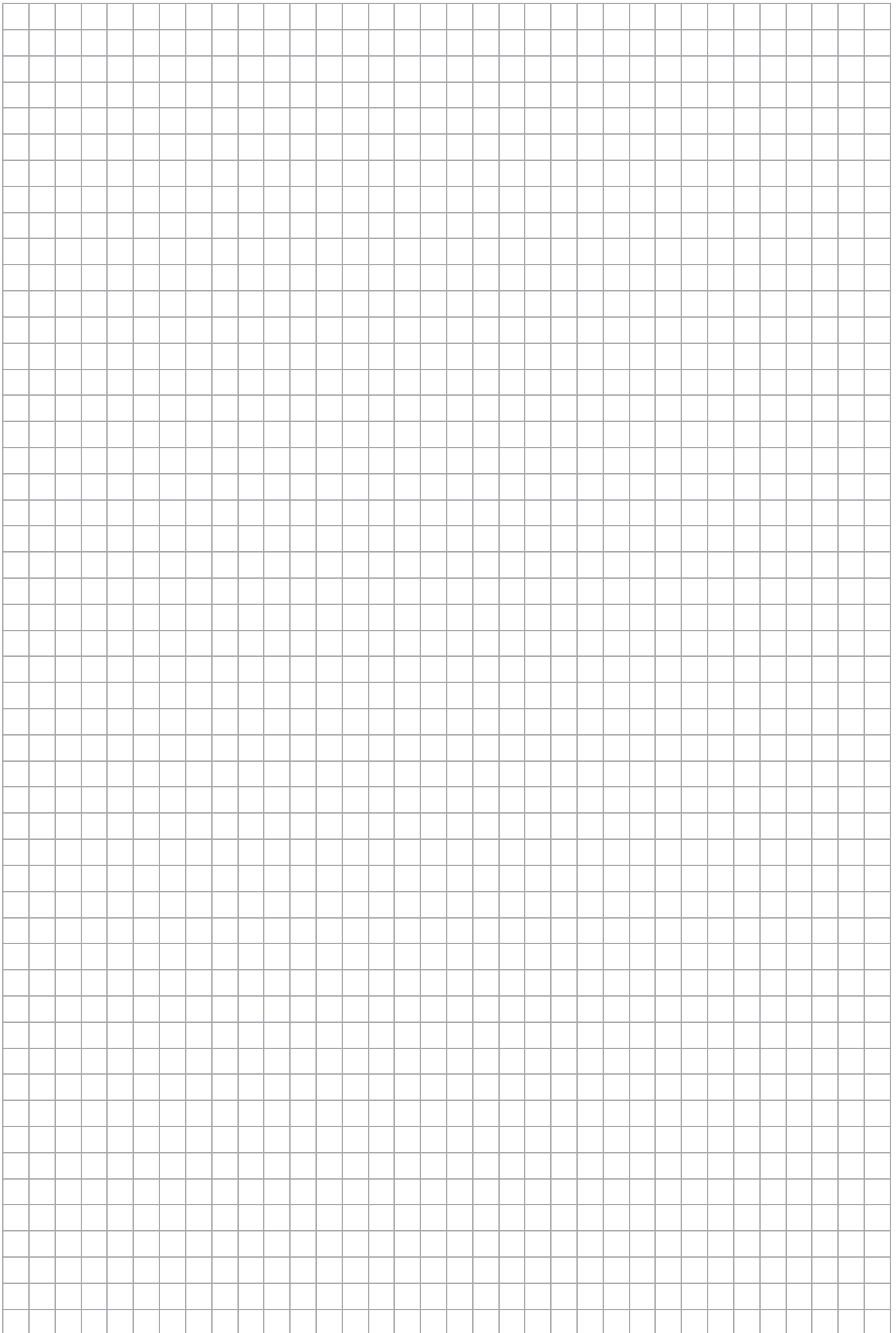



EVROPSKÁ UNIE
EVROPSKÝ FOND PRO REGIONÁLNÍ ROZVOJ
INVESTICE DO VAŠÍ BUDOUCNOSTI



EUROPEAN UNION
EUROPEAN REGIONAL DEVELOPMENT FUND
INVESTMENT IN OYUR FUTURE



ЕВРОПЕЙСКИЙ СОЮЗ
ЕВРОПЕЙСКИЙ ФОНД РЕГИОНАЛЬНОГО РАЗВИТИЯ
ИНВЕСТИЦИИ В ВАШЕ БУДУЩЕЕ

MOSBUILD 2013

VÁŠ PRODEJCE RIHO / YOUR RIHO ADVISOR:

RIHO CZ, a.s.

Suchý 37, 680 01 Boskovice
Czech Republic
tel.: +420 516 468 222
fax: +420 516 468 216
info@riho.cz



Výrobce si vyhrazuje právo technických a cenových změn.
The right to change price and technical characteristics
is reserved by the manufacturer.

www.riho.cz

www.riho.ru

www.riho.sk

www.riho.by

www.riho.si

www.rihoro.ro